

Feature

This device is Pb-Free, Halogen Free/BFR Free and RoHS compliant.

PNMT6N1A is composed by two transistors (NPN+PNP).

PNP Transistor:

- Very low collector to emitter saturation voltage
- DC current gain >100
- 3A continuous collector current
- PNP epitaxial planar silicon transistor

NPN Transistor:

- Emitter -Base Breakdown Voltage 10V
- Low Saturation Voltage 80mv
- 0.15A continuous collector current
- NPN switch transistor

- PNP

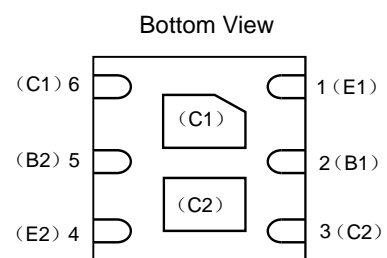
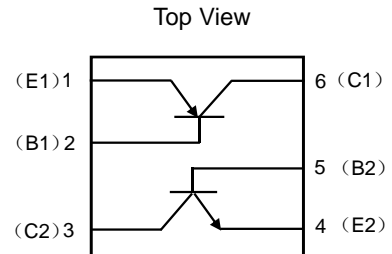
Absolute maximum rating @25 °C

Parameter	Symbol	Value	Units
Collector-Emitter Breakdown Voltage	$V_{(BR)CEO}$	-30	V
Collector-Base Breakdown Voltage	$V_{(BR)CBO}$	-40	V
Emitter -Base Breakdown Voltage	$V_{(BR)EBO}$	-5	V
Collector Current	I_C	-3	A
Collector Peak Current	I_{CM}	-6	A
Base Current	I_B	-0.2	A
Base Peak Current	I_{BM}	-0.5	A
Total Dissipation @25°C	P_{tot}	1.2	W
Storage Temperature	T_{stg}	-65~150	°C
Max. Operating Junction Temperature	T_j	150	°C
Junction-to-Ambient Thermal Resistance ⁽¹⁾	$R_{\theta JA}$	104	°C/ W

Note 1: Surface mounted on FR-4 Board using 1 square inch pad size, 1oz copper

Electrical characteristics per line@25°C (unless otherwise specified)

Parameter	Symbol	Conditions	Min.	Typ.	Max.	Units
DC Current Gain	h_{FE}	$I_C=-1mA, V_{CE}=-5.0V$	150			-
		$I_C=-1A, V_{CE}=-5.0V$	100		-	
Collector-Emitter Saturation Voltage	$V_{CE(sat)}$	$I_C=-0.1A, I_B=-1mA$	-		-0.14	V
		$I_C=-0.5A, I_B=-50mA$	-		-0.17	
		$I_C=-1A, I_B=-100mA$	-		-0.31	
Base-Emitter Saturation Voltage	$V_{BE(sat)}$	$I_C=-1A, I_B=-0.05mA$			-1.1	V
Collector Cut-off Current ($I_E=0$)	I_{CBO}	$V_{CB}=-40V$			-0.1	μA
		$V_{CB}=-30V, T_C=125^\circ C$			-20	
Emitter Cut-off Current($I_C=0$)	I_{EBO}	$V_{EB}=-5V$			-0.1	μA

➤ NPN

Absolute maximum rating@25°C

Parameter	Symbol	Value	Units
Collector-Emitter Breakdown Voltage	$V_{(BR)CEO}$	50	V
Collector-Base Breakdown Voltage	$V_{(BR)CBO}$	80	V
Emitter -Base Breakdown Voltage	$V_{(BR)EBO}$	10	V
Collector Current	I_C	0.15	A
Total Dissipation @25°C	P_{tot}	0.15	W
Storage Temperature	T_{stg}	-65~150	°C
Max. Operating Junction Temperature	T_j	150	°C

Electrical characteristics per line@25°C (unless otherwise specified)

Parameter	Symbol	Conditions	Min.	Typ.	Max.	Units
Collector-Base Breakdown Voltage	BV_{CBO}	$I_C=50\mu A$	80			V
Collector-Emitter Breakdown Voltage	BV_{CEO}	$I_C=1mA$	50			V
Emitter-Base Breakdown Voltage	BV_{EBO}	$I_E=50\mu A$	10			V
Collector Cut-off Current ($I_E=0$)	I_{CBO}	$V_{CB}=60V$			0.15	μA

Electrical characteristics per line@25 °C (unless otherwise specified)

Parameter	Symbol	Conditions	Min.	Typ.	Max.	Units
Emitter Cut-off Current($I_{C=0}$)	I_{EBO}	$V_{EB}=7V$			0.1	μA
DC Current Gain	h_{FE}	$I_C=1mA, V_{CE}=6V$	200		350	-
Collector-Emitter Saturation Voltage	$V_{CE(sat)}$	$I_C=50mA, I_B=5mA$	-		0.08	V
Transition frequency	f_T	$V_{CE}=12V, I_E=-2mA, f=100MHz$		220		MHz
Output Capacitance	C_{ob}	$V_{CE}=12V, I_E=0mA, f=1MHz$		1.5	3.5	pF

Typical Characteristics

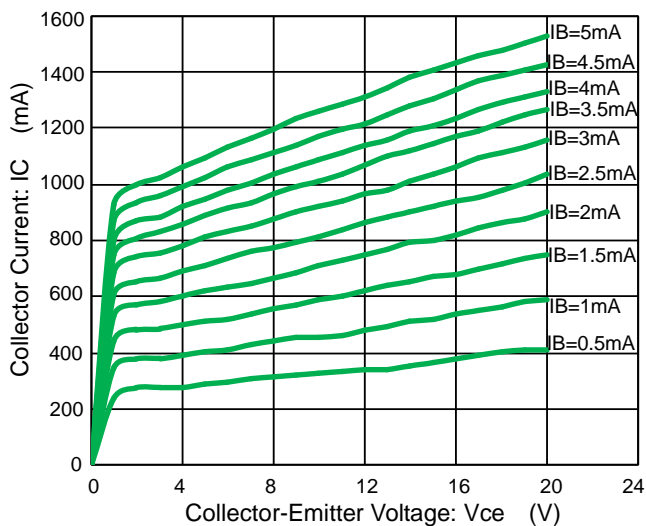

Fig 1. Collector Current vs. Collector-Emittor Voltage

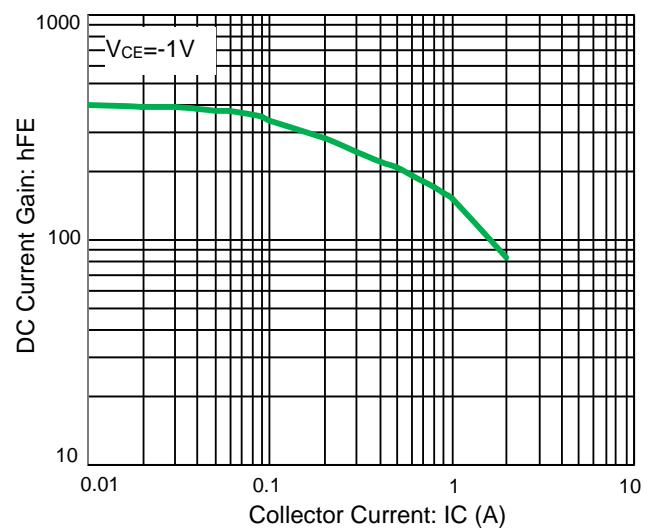

Fig 2. DC Current Gain

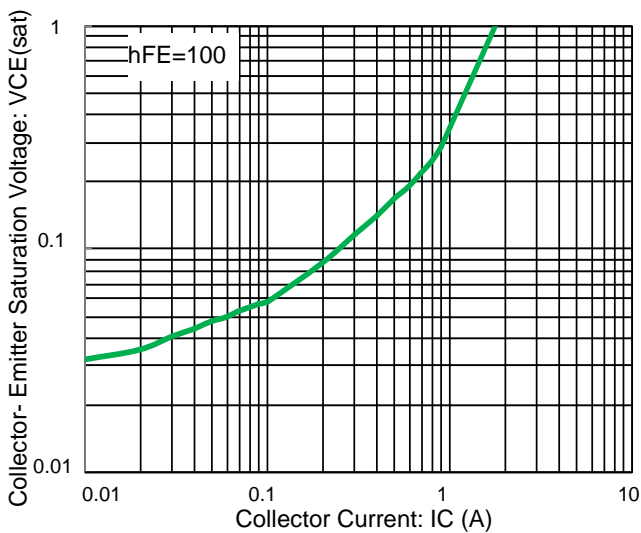

Fig 3. C-E saturation Voltage vs. Collector Current

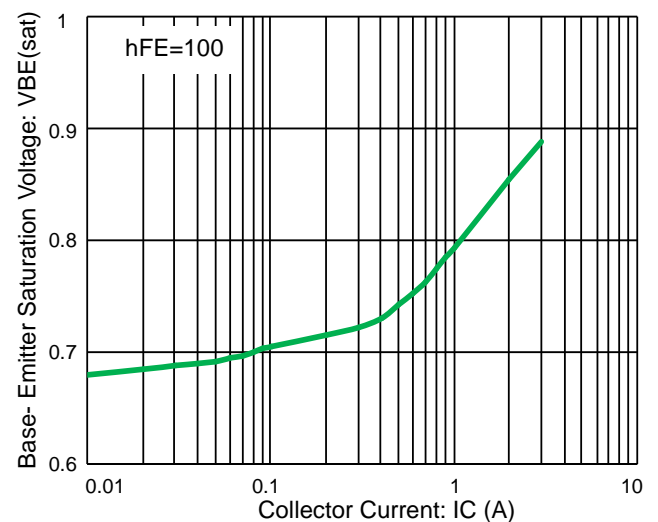

Fig 4. B-E Saturation Voltage vs. Collector Current

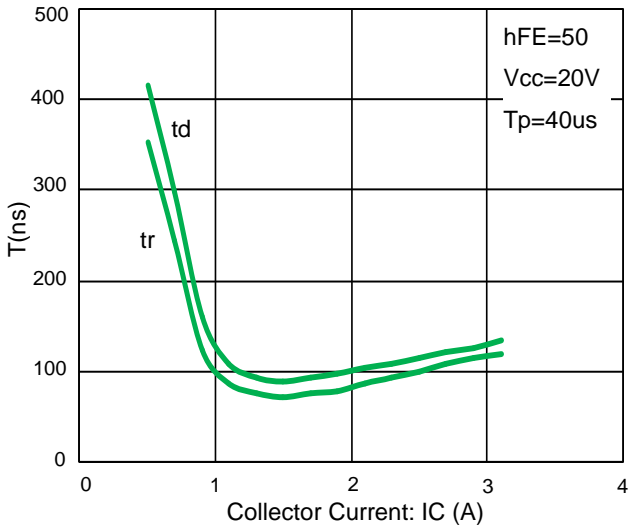

Fig 5. Switching Times Resistive Load

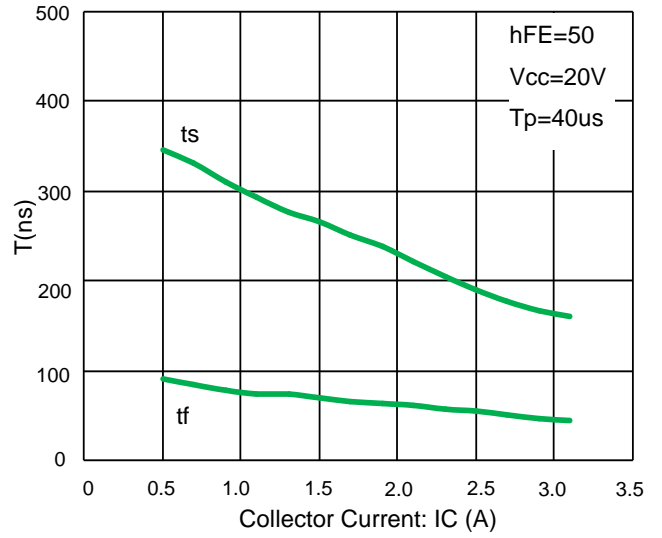

Fig 6. Switching Times Resistive Load

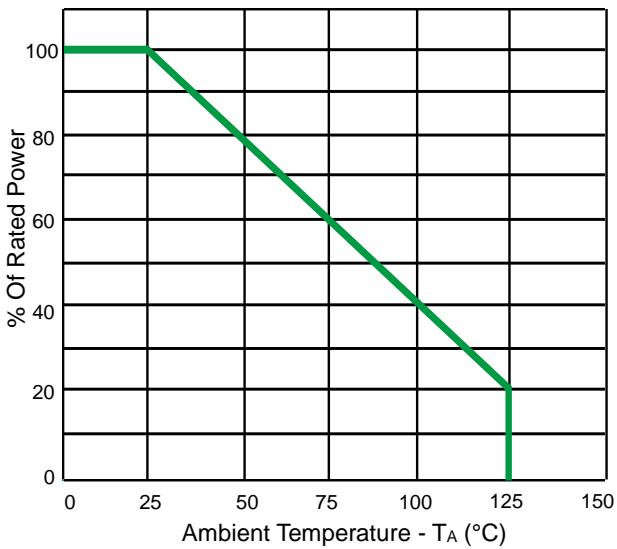

Fig 7. Power Derating Curve

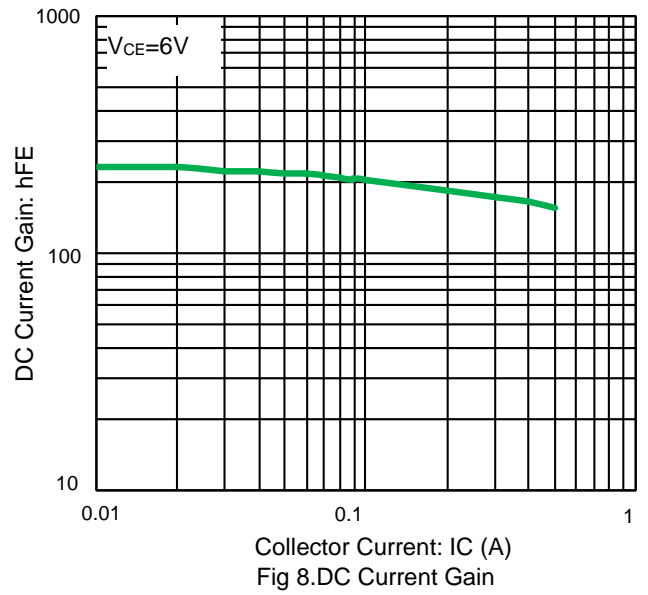

Fig 8. DC Current Gain

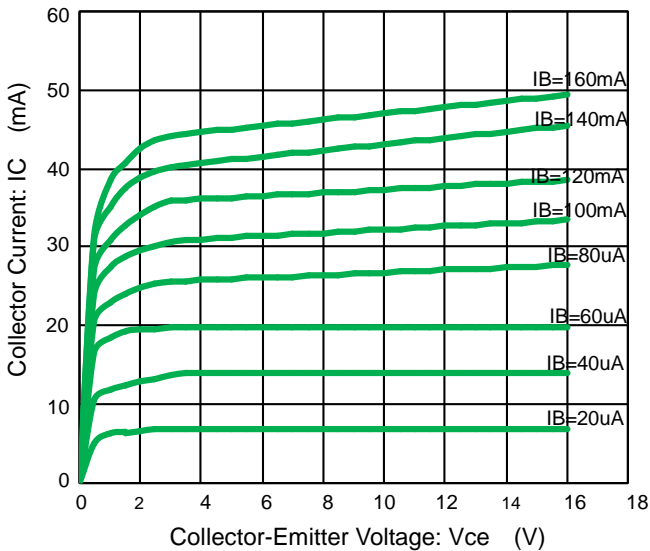

Fig 9. Collector Current vs. Collector-Emitter Voltage

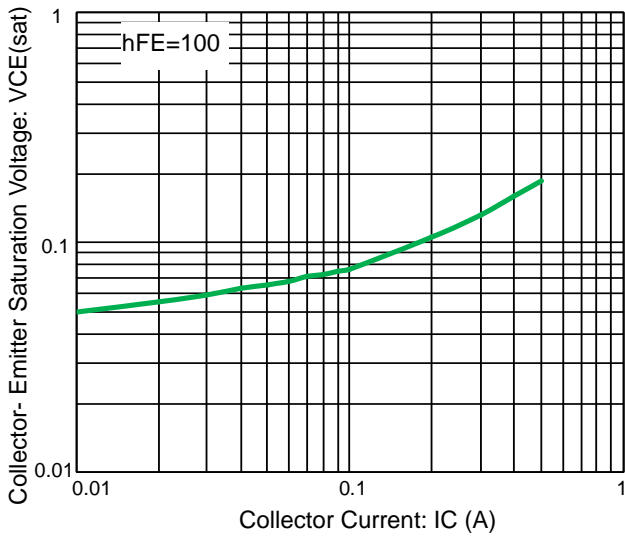

Fig 10. C-E saturation Voltage vs. Collector Current

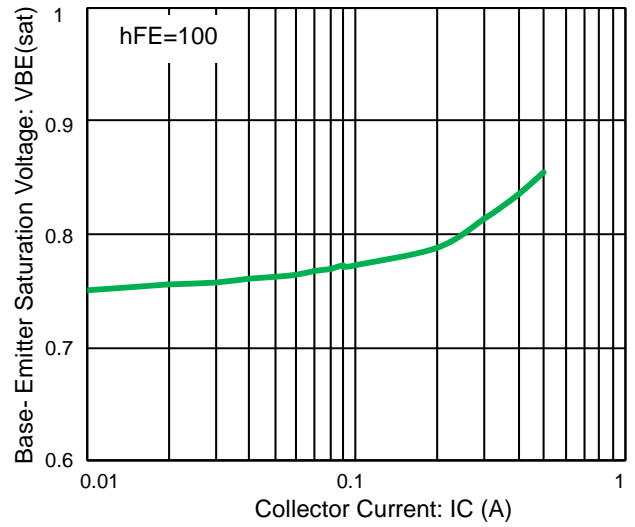

Fig 11. B-E Saturation Voltage vs. Collector Current

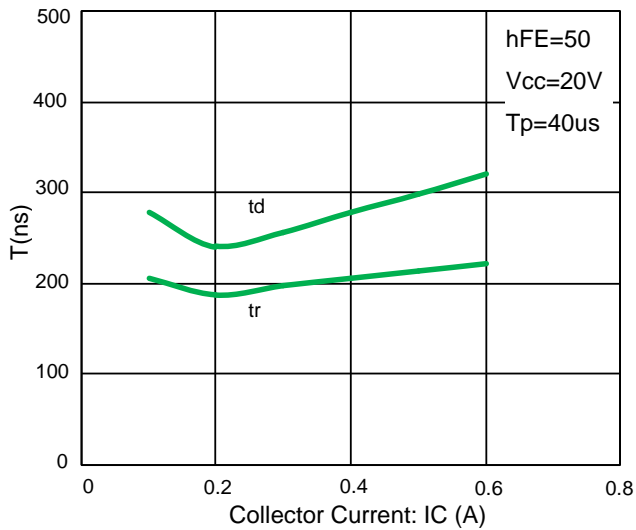

Fig 12. Switching Times Resistive Load

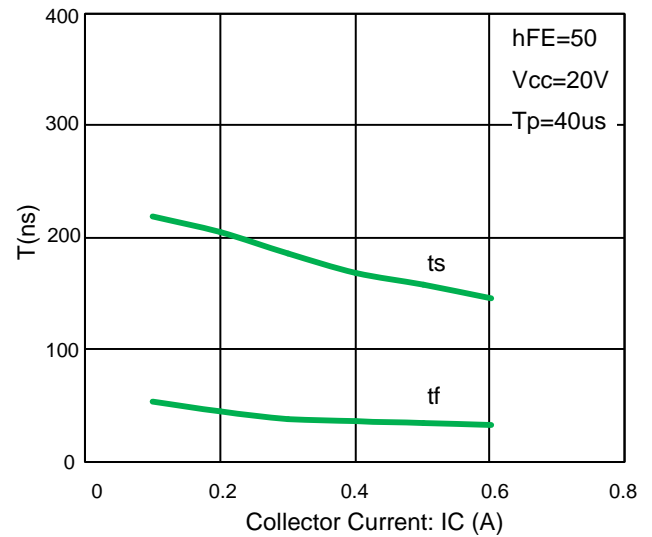
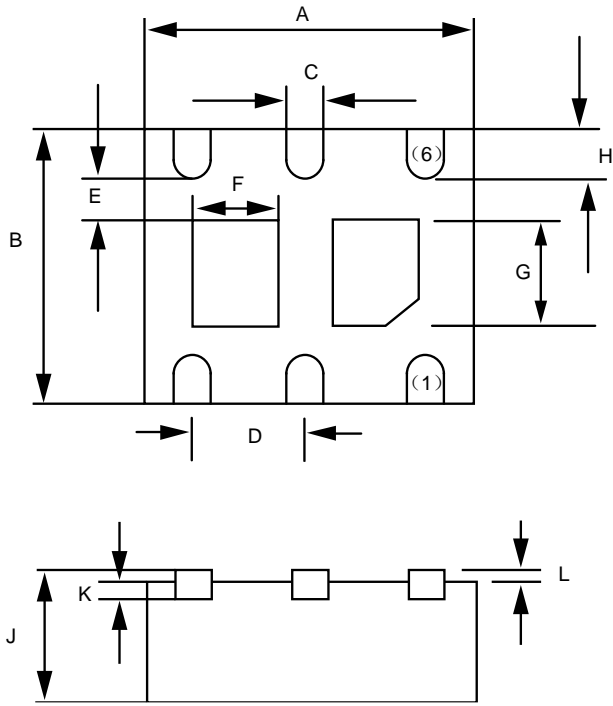
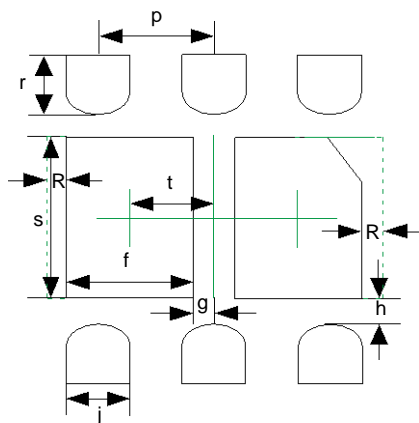

Fig 13. Switching Times Resistive Load

Product dimension DFN-6L(2*2)



Dim	Millimeters		Inches	
	MIN	MAX	MIN	MAX
A	1.924	2.076	0.076	0.082
B	1.924	2.076	0.076	0.082
C	0.250	0.350	0.010	0.014
D	0.650 (typ.)		0.026 (typ.)	
E	0.200 MIN.		0.008 MIN.	
F	0.520	0.720	0.020	0.028
G	0.900	1.100	0.035	0.043
H	0.174	0.326	0.007	0.013
J	0.550	0.650	0.021	0.027
K	0.206 REF		0.206 REF	
L	0.203 REF		0.203 REF	



If there is enough place in PCB. It can be mounted with copper along the dotted line in order to optimize thermal design.

Dim	Millimeters	
	MIN	MAX
p	0.60	0.70
r	0.40	0.50
s	1.05	1.15
t	0.42	0.52
f	0.67	0.77
g	0.06	0.16
h	0.1	0.2
j	0.35	0.45
R	0.1	0.2

Marking information

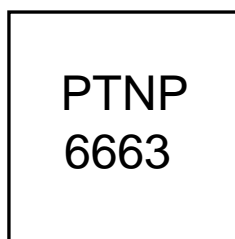

Ordering information

Device	Package	Reel	Shipping
PNMT6N1A	DFN-6L (2*2)	7"	3000 / Tape & Reel

IMPORTANT NOTICE

 and **Prisemi**[®] are registered trademarks of **Prisemi Electronics Co., Ltd (Prisemi)** ,Prisemi reserves the right to make changes without further notice to any products herein. Prisemi makes no warranty, representation or guarantee regarding the suitability of its products for any particular purpose, nor does Prisemi assume any liability arising out of the application or use of any product or circuit, and specifically disclaims any and all liability, including without limitation special, consequential or incidental damages. "Typical" parameters which may be provided in Prisemi data sheets and/or specifications can and do vary in different applications and actual performance may vary over time. All operating parameters, including "Typicals" must be validated for each customer application by customer's technical experts. Prisemi does not convey any license under its patent rights nor the rights of others. The products listed in this document are designed to be used with ordinary electronic equipment or devices, Should you intend to use these products with equipment or devices which require an extremely high level of reliability and the malfunction of with would directly endanger human life (such as medical instruments, aerospace machinery, nuclear-reactor controllers, fuel controllers and other safety devices), please be sure to consult with our sales representative in advance.

Website: <http://www.prisemi.com>

For additional information, please contact your local Sales Representative.

©Copyright 2009, Prisemi Electronics

 **Prisemi**[®] is a registered trademark of Prisemi Electronics.

All rights are reserved.