

Description

Surface Mount General Purpose Silicon Rectifiers

Reverse Voltage 50 to 1000 V

Forward Current 1 A

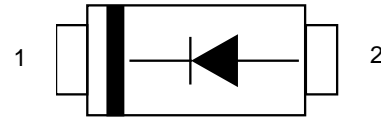

SOD123-FL

Maximum Ratings and Electrical characteristics per line@25°C (unless otherwise specified)
Single phase half-wave 60 Hz, resistive or inductive load, for capacitive load current derate by 20 %

Parameter	Symbols	P1N4001W	P1N4002W	P1N4003W	P1N4004W	P1N4005W	P1N4006W	P1N4007W	Units
Maximum Repetitive Peak Reverse Voltage	V_{RRM}	50	100	200	400	600	800	1000	V
Maximum RMS voltage	V_{RMS}	35	70	140	280	420	560	700	V
Maximum DC Blocking Voltage	V_{DC}	50	100	200	400	600	800	1000	V
Maximum Average Forward Rectified Current at $T_a = 65\text{ }^{\circ}\text{C}$	$I_{F(AV)}$	1							A
Peak Forward Surge Current 8.3 ms Single Half Sine Wave Superimposed on Rated Load (JEDEC Method)	I_{FSM}	25							A
Maximum Instantaneous Forward Voltage at 1 A	V_F	1.1							V
Maximum DC Reverse Current $T_a = 25\text{ }^{\circ}\text{C}$ at Rated DC Blocking Voltage $T_a = 125\text{ }^{\circ}\text{C}$	I_R	5 100							μA
Typical Junction Capacitance ¹⁾	C_j	4							pF
Typical Thermal Resistance ²⁾	$R_{\theta JA}$	180							$^{\circ}\text{C}/\text{W}$
Operating and Storage Temperature Range	T_j, T_{stg}	-55~+150							$^{\circ}\text{C}$

1) Measured at 1 MHz and applied reverse voltage of 4 V D.C

2) Thermal resistance from junction to ambient at 0.375" (9.5 mm) lead length, P.C.B. mounted

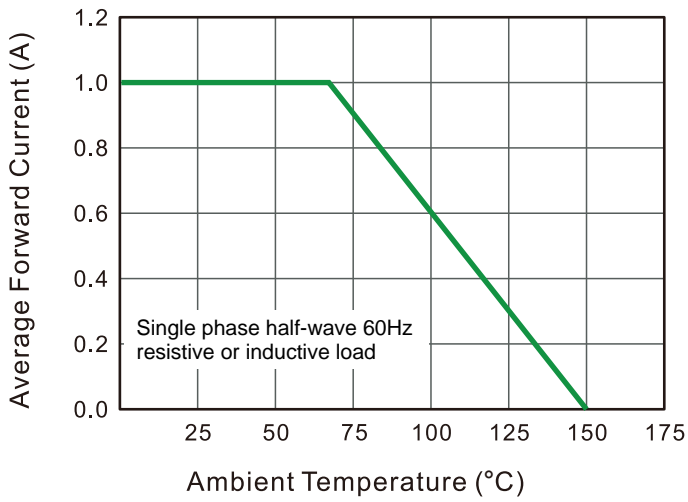

Fig.1 Forward Current Derating Curve

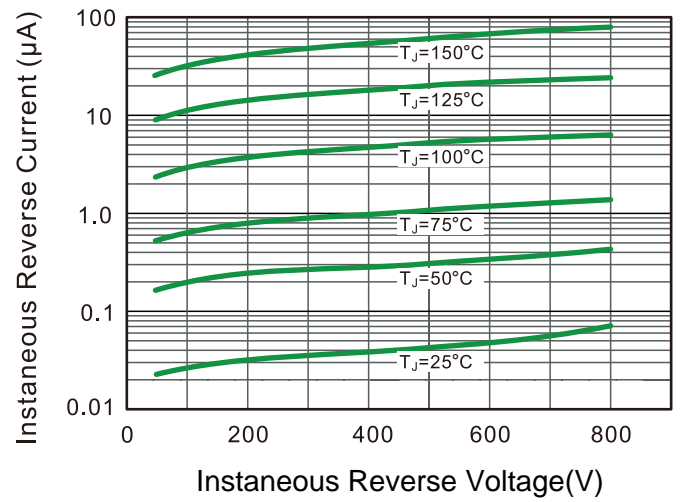

Fig.2 Typical Instantaneous Reverse Characteristics

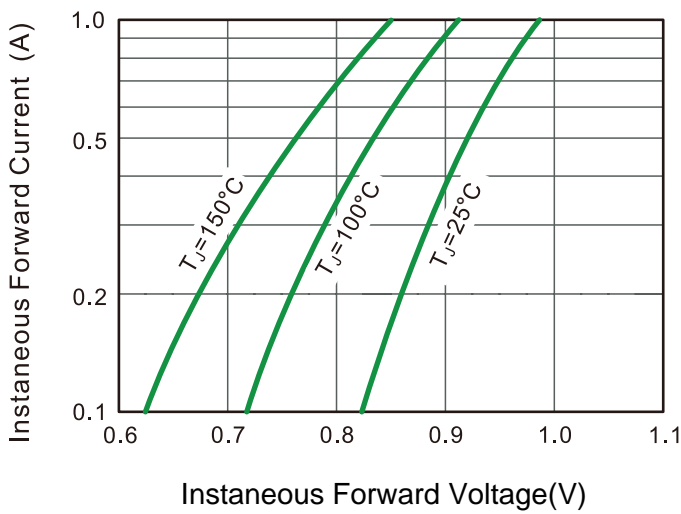

Fig.3 Typical Forward Characteristic

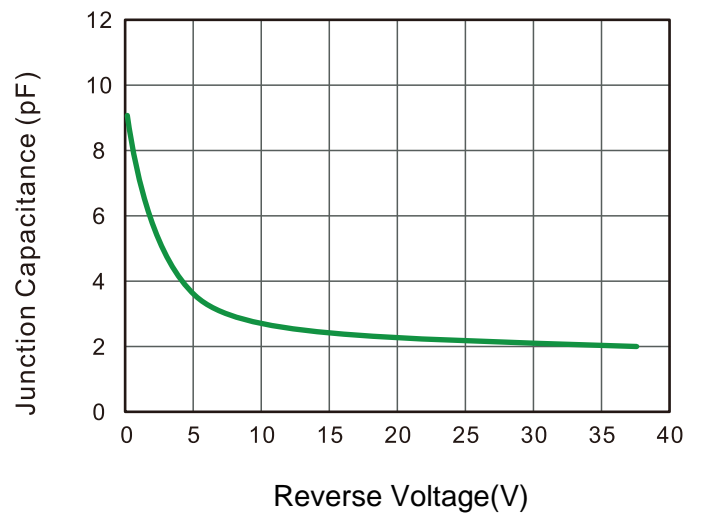
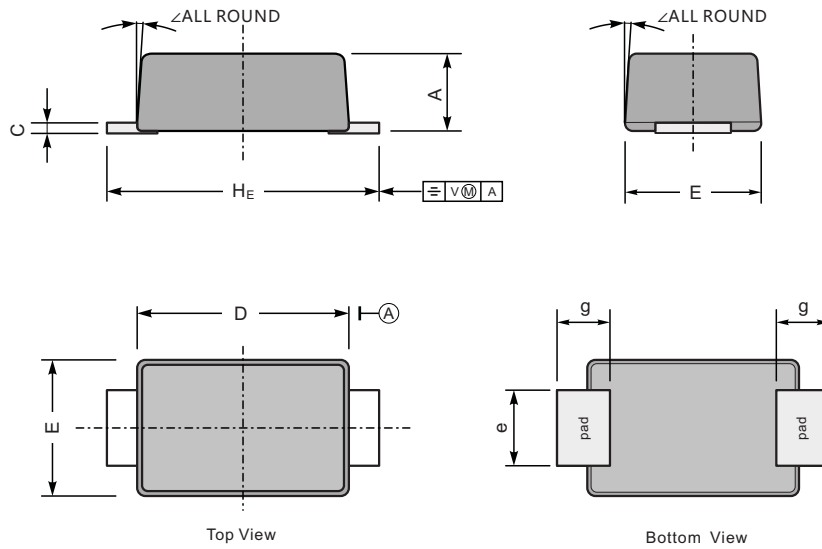

Fig.4 Typical Junction Capacitance

Product dimension(SOD-123FL)

Plastic surface mounted package; 2 leads



UNIT		A	C	D	E	e	g	H_E	\angle
mm	max	1.1	0.20	2.9	1.9	1.1	0.9	3.8	7°
	min	0.9	0.12	2.6	1.7	0.8	0.7	3.5	
mil	max	43	7.9	114	75	43	35	150	
	min	35	4.7	102	67	31	28	138	

The recommended mounting pad size

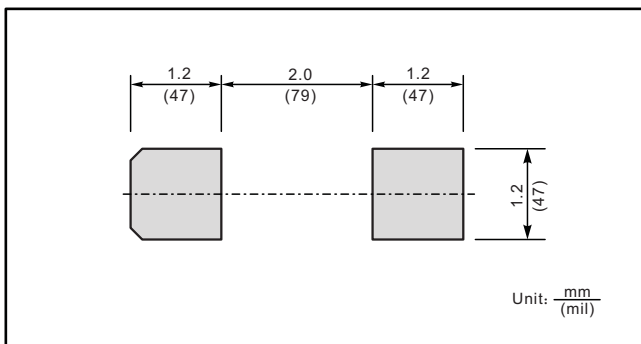

• Recommended condition of flow soldering

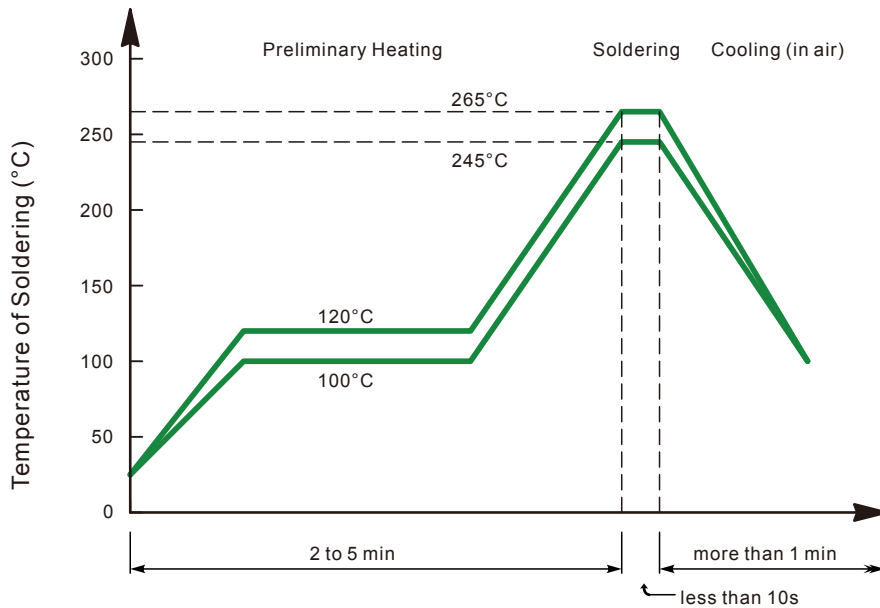

• Recommended condition of reflow soldering

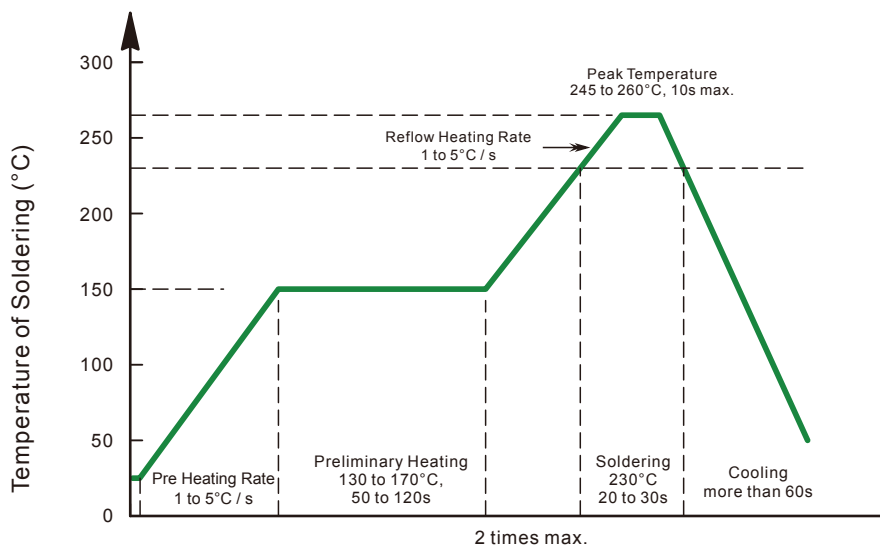

Recommended peak temperature is over 245 °C. If peak temperature is below 245 °C, you may adjust the following parameters; time length of peak temperature (longer), time length of soldering (longer), thickness of solder paste (thicker)

• Condition of hand soldering

Temperature: 370°C
 Time: 3s max.
 Times: one time

• Remark:

Lead free solder paste (96.5Sn/3.0Ag/0.5Cu)

 and **Prisemi**[®] are registered trademarks of **Prisemi Electronics Co., Ltd (Prisemi)** ,Prisemi reserves the right to make changes without further notice to any products herein. Prisemi makes no warranty, representation or guarantee regarding the suitability of its products for any particular purpose, nor does Prisemi assume any liability arising out of the application or use of any product or circuit, and specifically disclaims any and all liability, including without limitation special, consequential or incidental damages. “Typical” parameters which may be provided in Prisemi data sheets and/or specifications can and do vary in different applications and actual performance may vary over time. All operating parameters, including “Typicals” must be validated for each customer application by customer’s technical experts. Prisemi does not convey any license under its patent rights nor the rights of others. The products listed in this document are designed to be used with ordinary electronic equipment or devices, Should you intend to use these products with equipment or devices which require an extremely high level of reliability and the malfunction of with would directly endanger human life (such as medical instruments, aerospace machinery, nuclear-reactor controllers, fuel controllers and other safety devices), please be sure to consult with our sales representative in advance.

Website: <http://www.prisemi.com>

For additional information, please contact your local Sales Representative.

©Copyright 2009, Prisemi Electronics

 **Prisemi**[®] is a registered trademark of Prisemi Electronics.

All rights are reserved.