

Description

- Surface Mount Fast Recovery Rectifiers
- Reverse Voltage - 50 to 1000 V
- Forward Current - 1 A

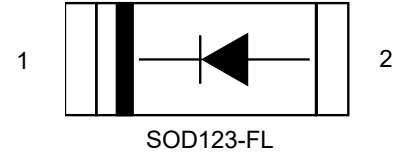

Features

- For surface mounted applications
- Low profile package
- Glass Passivated Chip Junction
- Easy to pick and place
- Fast reverse recovery time
- Lead free in comply with EU RoHS 2011/65/EU directives

Mechanical Data

- Case: SOD-123FL
- Terminals: Solderable per MIL-STD-750, Method 2026
- pprox. Weight: 15mg 0.00053oz

Maximum Ratings and Electrical characteristics per line @ 25°C (unless otherwise specified)
Single phase half-wave 60 Hz, resistive or inductive load, for capacitive load current derate by 20 %

Parameter	Symbols	PFR101W	PFR102W	PFR103W	PFR104W	PFR105W	PFR106W	PFR107W	Units
Maximum Repetitive Peak Reverse Voltage	V_{RRM}	50	100	200	400	600	800	1000	V
Maximum RMS Voltage	V_{RMS}	35	70	140	280	420	560	700	V
Maximum DC Blocking Voltage	V_{DC}	50	100	200	400	600	800	1000	V
Maximum Average Forward Rectified Current at $T_C = 125^\circ\text{C}$	$I_{F(AV)}$	1							A
Peak Forward Surge Current 8.3 ms Single Half Sine Wave Superimposed on Rated Load	I_{FSM}	30							A
Maximum Forward Voltage at 1 A	V_F	1.3							V
Maximum DC Reverse Current $T_a = 25^\circ\text{C}$ at Rated DC Blocking Voltage $T_a = 125^\circ\text{C}$	I_R	5 100							μA
Maximum Reverse Recovery Time ¹⁾	t_{rr}	150				250	500		ns
Typical Junction Capacitance ²⁾	C_j	15							pF
Typical Thermal Resistance ³⁾	$R_{\theta JA}$	85							$^\circ\text{C}/\text{W}$
Operating and Storage Temperature Range	T_j, T_{stg}	-55~+150							$^\circ\text{C}$

1) Measured with $I_F = 0.5\text{ A}$, $I_R = 1\text{ A}$, $I_{rr} = 0.25\text{ A}$

2) Measured at 1 MHz and applied reverse voltage of 4 V D.C

3) P.C.B. mounted with 2.0" X 2.0" (5 X 5 cm) copper pad areas.

Typical Characteristics

Fig.1 Forward Current Derating Curve

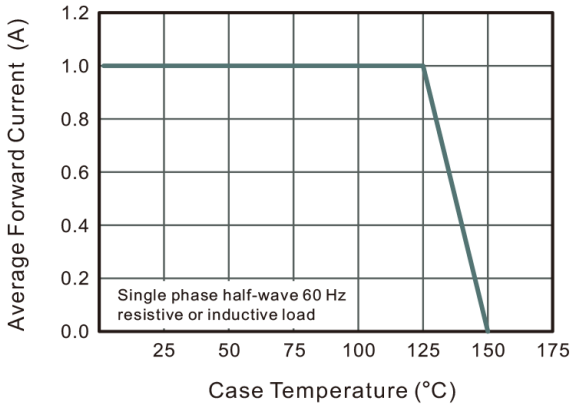

Fig.2 Typical Reverse Characteristics

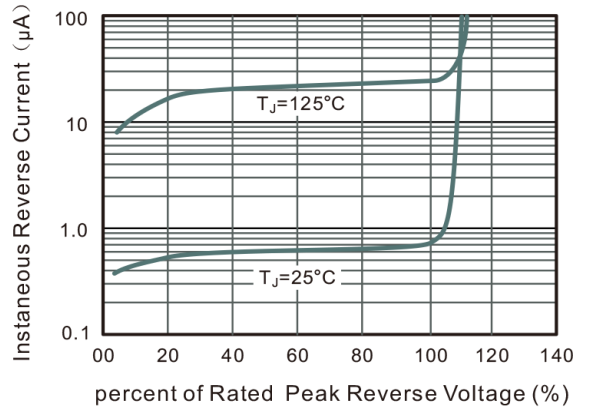

Fig.3 Typical Instantaneous Forward Characteristics

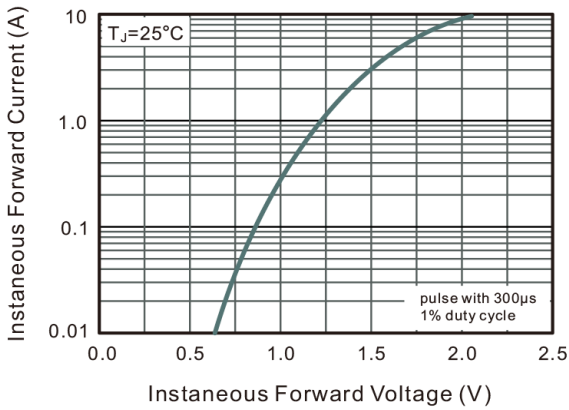

Fig.4 Typical Junction Capacitance

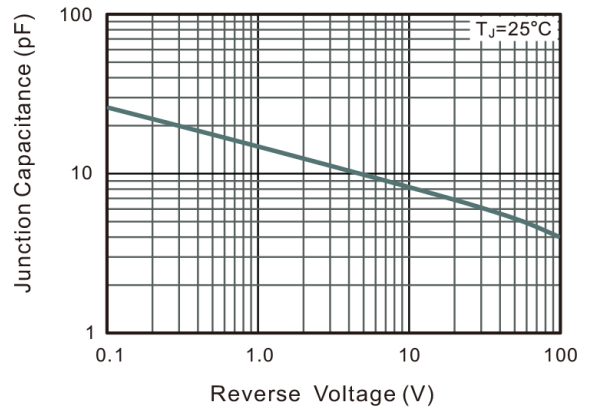
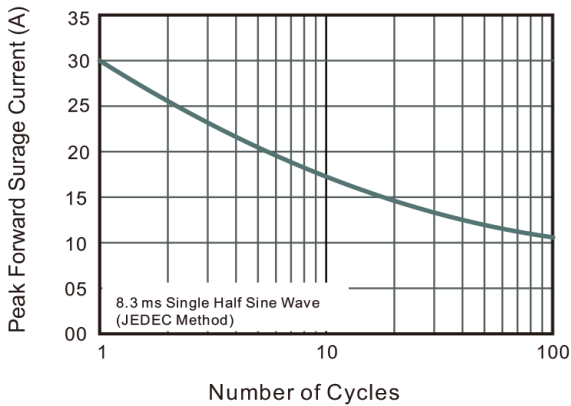
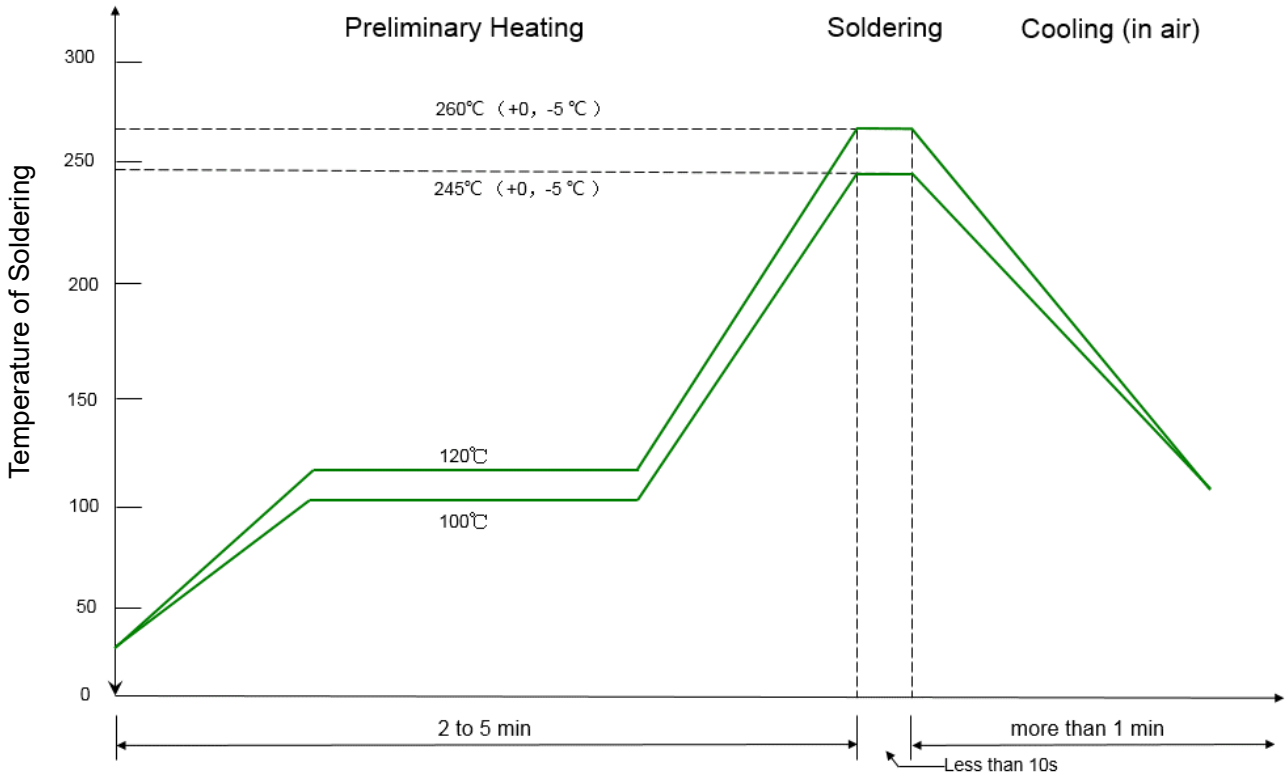

Fig.5 Maximum Non-Repetitive Peak Forward Surge Current



Solder Reflow Recommendation



Remark: Pb free for 260°C; Pb for 245°C

Product dimension (SOD-123FL)

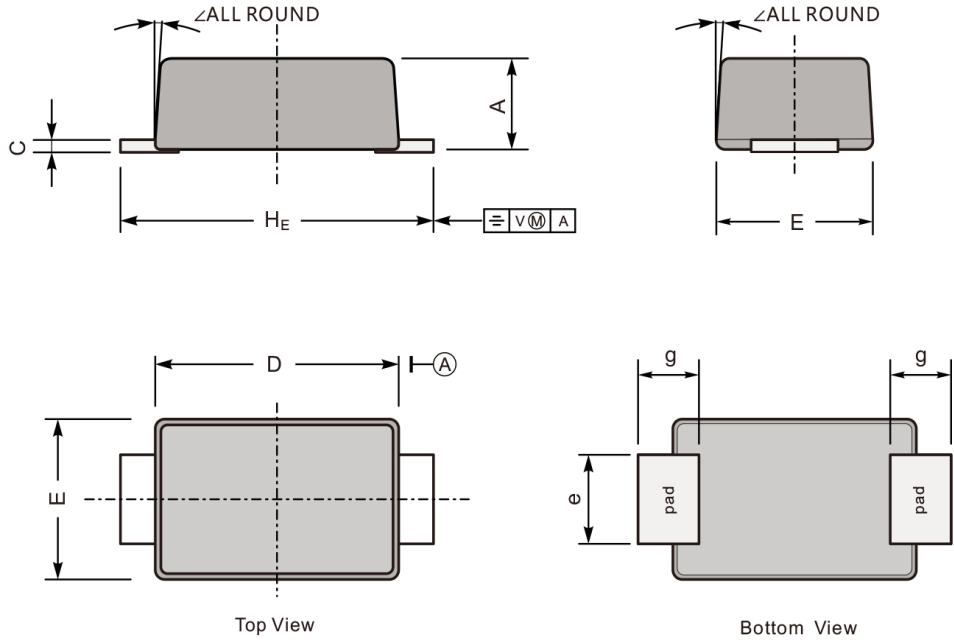

UNIT		A	C	D	E	e	g	H _E	∠
mm	max	1.1	0.20	2.9	1.9	1.1	0.9	3.8	7°
	min	0.9	0.12	2.6	1.7	0.8	0.7	3.5	
mil	max	43	7.9	114	75	43	35	150	
	min	35	4.7	102	67	31	28	138	

The recommended mounting pad size

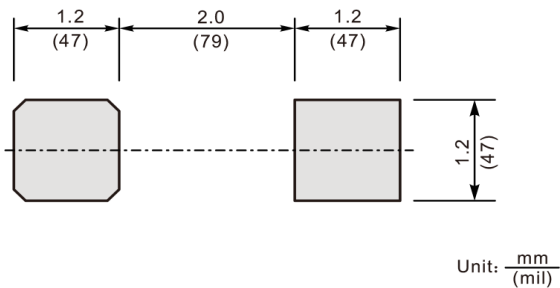

Marking

Type number	Marking code
PFR101W	F2
PFR102W	
PFR103W	
PFR104W	F5
PFR105W	
PFR106W	F7
PFR107W	

IMPORTANT NOTICE

 and **Prisemi**[®] are registered trademarks of **Prisemi Electronics Co., Ltd** (Prisemi). Prisemi reserves the right to make changes without further notice to any products herein. Prisemi makes no warranty, representation or guarantee regarding the suitability of its products for any particular purpose, nor does Prisemi assume any liability arising out of the application or use of any product or circuit, and specifically disclaims any and all liability, including without limitation special, consequential or incidental damages. "Typical" parameters which may be provided in Prisemi data sheets and/or specifications can and do vary in different applications and actual performance may vary over time. All operating parameters, including "Typicals" must be validated for each customer application by customer's technical experts. Prisemi does not convey any license under its patent rights nor the rights of others. The products listed in this document are designed to be used with ordinary electronic equipment or devices, Should you intend to use these products with equipment or devices which require an extremely high level of reliability and the malfunction of with would directly endanger human life (such as medical instruments, aerospace machinery, nuclear-reactor controllers, fuel controllers and other safety devices), please be sure to consult with our sales representative in advance.

Website: <http://www.prisemi.com>

For additional information, please contact your local Sales Representative.

©Copyright 2009, Prisemi Electronics

 **Prisemi**[®] is a registered trademark of Prisemi Electronics.

All rights are reserved.