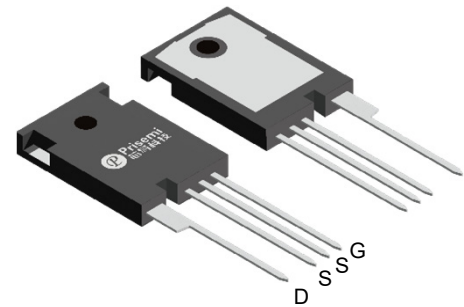


**Description**

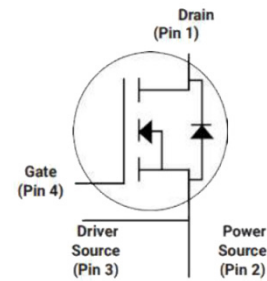
MOSFET Product Summary		
$V_{DS}(V)$	$R_{DS(on)}(m\Omega)$	$I_D(A)$
1200	40@ $V_{GS} = 15V$	68


**TO-247-4L**
**Feature**

- High Blocking Voltage with Low On-Resistance
- High Speed Switching with Low Capacitances
- Avalanche Ruggednes

**Applications**

- Solar Inverters
- Switch Mode Power Supplies
- UPS
- Battery Chargers


**Schematic diagram**
**Absolute maximum rating@25°C**

Parameter	Symbol	Rating	Unit
Drain-Source Voltage	$V_{DS}$	1200	V
Gate-Source Voltage	$V_{GS}$	-4/+18	V
Gate-Source Voltage(Absolute Maximum Values)	$V_{GSmax}$	-8/+22	V
Continuous Drain Current @ $V_{GS}=15V$	$T_C=25^\circ C$	68	A
	$T_C=100^\circ C$	48	
Pulsed Drain Current	$I_{DM}$	120	A
Power Dissipation	$P_D$	357	W
Operating Junction and Storage Temperature	$T_J, T_{STG}$	-40 to +175	°C

**Thermal Resistance**

Parameter	Symbol	Min	Typ	Max	Unit
Thermal Resistance, Junction-to-Case	$R_{\theta JC}$	-	-	0.42	°C/W
Thermal Resistance, Junction-to-Ambient	$R_{\theta JA}$	-	-	40	°C/W

## Electrical characteristics per line@25°C (unless otherwise specified)

Parameter	Symbol	Conditions	Min.	Typ.	Max.	Units
<b>Statistic Characteristics</b>						
Drain-Source Breakdown Voltage	$BV_{DSS}$	$V_{GS} = 0V, I_D = 100\mu A$	1200	-	-	V
Zero Gate Voltage Drain Current	$I_{DSS}$	$V_{DS} = 1200V, V_{GS} = 0V$ $T_C = 25^\circ C$	-	1.0	20	$\mu A$
		$V_{DS} = 1200V, V_{GS} = 0V$ $T_C = 175^\circ C$	-	5.0	-	
Gate-Body Leakage Current	$I_{GSS}$	$V_{GS} = 18V, V_{DS} = 0V$	-	-	100	nA
Gate Threshold Voltage	$V_{GS(th)}$	$V_{DS} = V_{GS}, I_D = 10mA$	2.2	3.0	4.0	V
Drain-Source On-State Resistance	$R_{DS(on)}$	$V_{GS} = 15V, I_D = 33.3A$ $T_J = 25^\circ C$	-	40	52	m $\Omega$
		$V_{GS} = 15V, I_D = 33.3A$ $T_J = 175^\circ C$	-	62	-	
		$V_{GS} = 18V, I_D = 33.3A$ $T_J = 25^\circ C$	-	32	40	
		$V_{GS} = 18V, I_D = 33.3A$ $T_J = 175^\circ C$	-	59	-	
Transconductance	$g_{fs}$	$V_{DS} = 20V, I_D = 33.3A$	-	20	-	S
<b>Dynamic Characteristics</b>						
Input Capacitance	$C_{iss}$	$V_{DS} = 1000V, V_{GS} = 0V,$ $V_{AC} = 25mV, f = 1MHz$	-	2766	-	pF
Output Capacitance	$C_{oss}$		-	125	-	
Reverse Transfer Capacitance	$C_{rss}$		-	14	-	
Turn-On Switching Energy	$E_{on}$	$V_{DS} = 800V, I_D = 20A$ $V_{GS} = -4/+15V,$ $R_G = 2.5\Omega, L = 120\mu H$	-	701	-	$\mu J$
Turn-Off Switching Energy	$E_{off}$		-	79	-	
Turn-on Delay Time	$t_{d(on)}$	$V_{DS} = 800V, I_D = 20A$ $V_{GS} = -4/+15V,$ $R_G = 2.5\Omega, L = 120\mu H$	-	13.4	-	ns
Turn-on Rise Time	$t_r$		-	5.4	-	
Turn-Off Delay Time	$t_{d(off)}$		-	32	-	
Turn-Off Fall Time	$t_f$		-	19	-	
Total Gate Charge	$Q_g$	$V_{DS} = 800V, I_D = 33.3A,$ $V_{GS} = 0/+15V$	-	112	-	nC
Gate-Source Charge	$Q_{gs}$		-	28	-	
Gate-Drain Charge	$Q_{gd}$		-	51	-	
Gate Resistance	$R_G$	$f = 1MHz, V_{AC} = 25mV$	-	0.6	-	$\Omega$
<b>Reverse Diode Characteristics</b>						
Diode Forward Voltage	$V_{SD}$	$V_{GS} = -4V, I_{SD} = 20A$ $T_J = 25^\circ C$	-	5.3	-	V
		$V_{GS} = -4V, I_{SD} = 20A$ $T_J = 175^\circ C$	-	4.8	-	
Reverse Recovery Time	$t_{rr}$	$V_{DS} = 800V, I_D = 33.3A,$ $di/dt = 1070A/\mu s$	-	55	-	ns
Reverse Recovery Charge	$Q_{rr}$		-	288	-	$\mu C$

Typical Characteristics

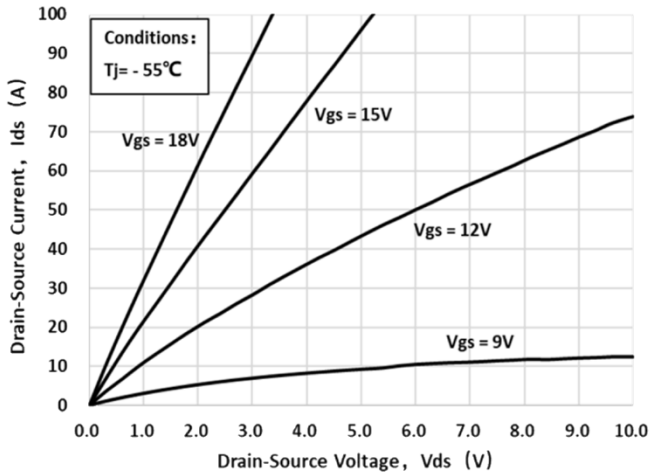


Fig 1. Output Characteristic ( $T_J = -55^\circ\text{C}$ )

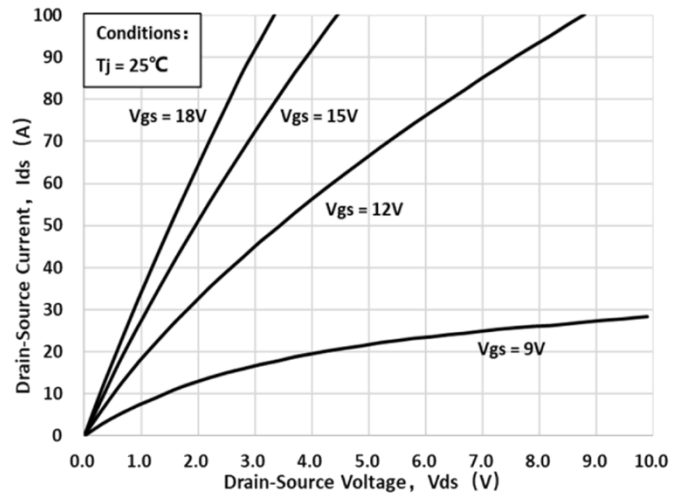


Fig 2. Output Characteristic ( $T_J = 25^\circ\text{C}$ )

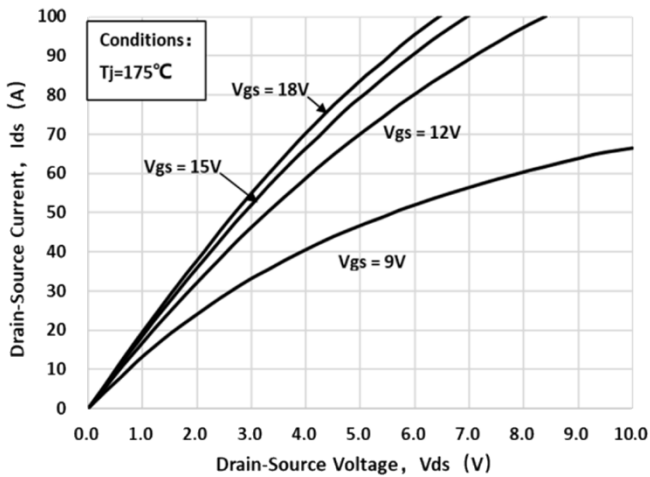


Fig 3. Output Characteristic ( $T_J = 175^\circ\text{C}$ )

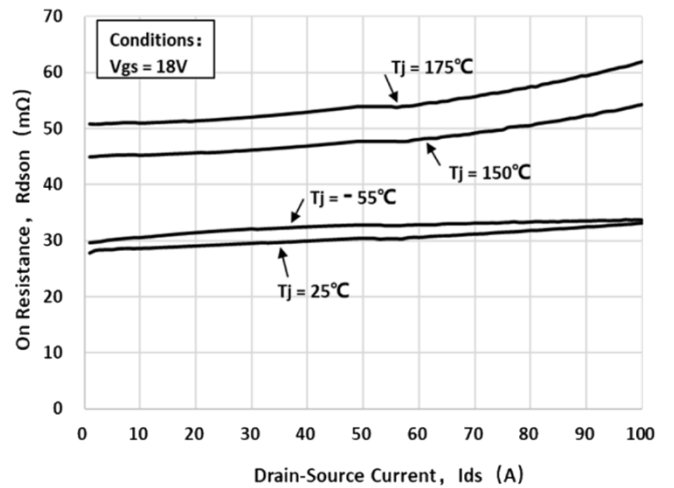


Fig 4:  $R_{ds(on)}$  Vs  $I_{ds}$  Characteristic

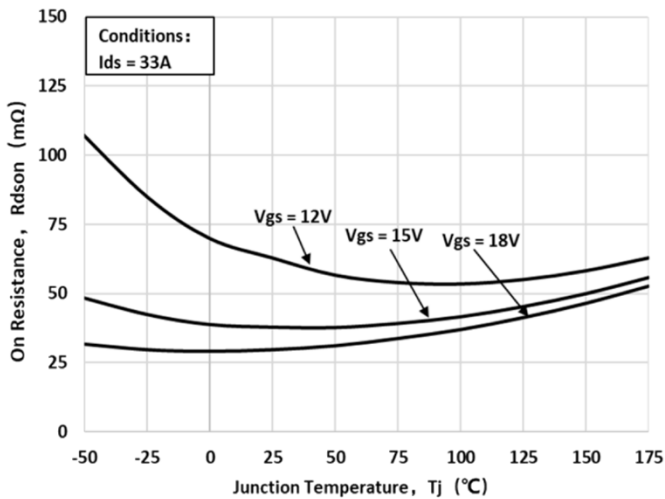


Fig 5:  $R_{ds(on)}$  vs. Temperature

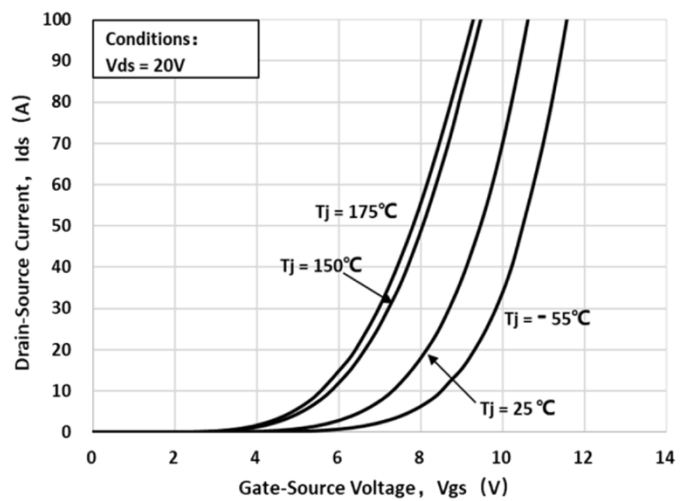


Fig 6: Transfer Characteristic

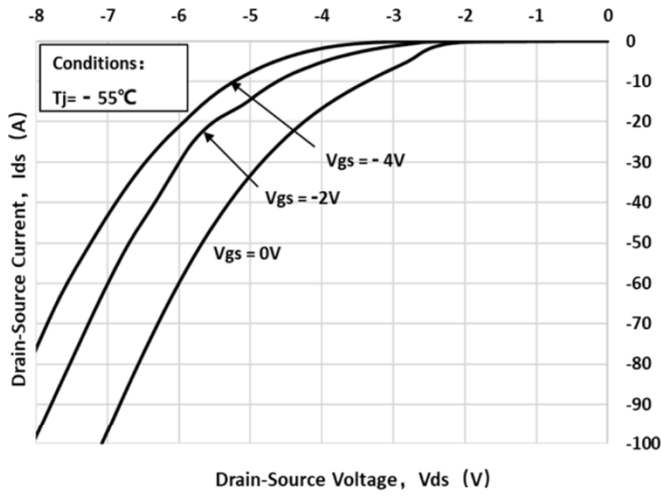


Fig 7: Body-diode Characteristic (T<sub>j</sub>=-55°C)

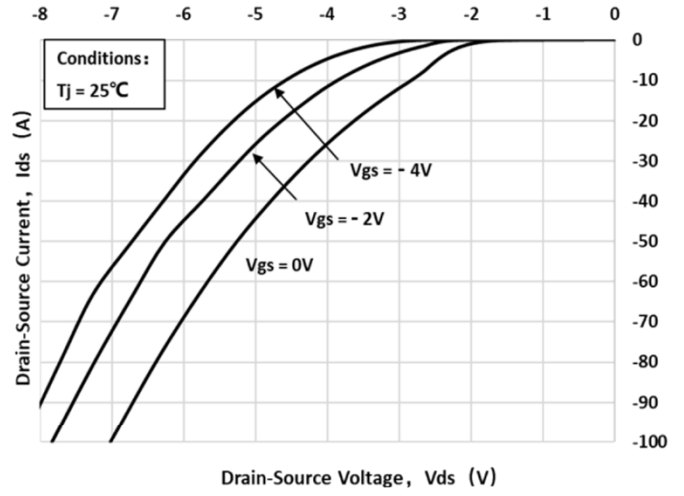


Fig 8: Body-diode Characteristic (T<sub>j</sub>=25°C)

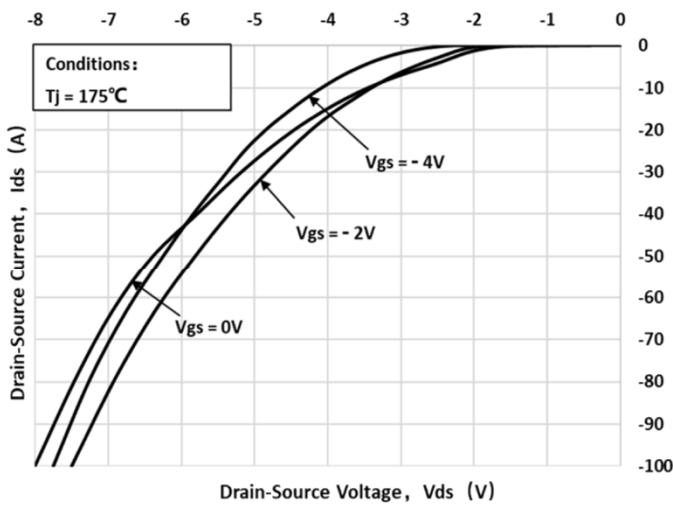


Fig 9: Body-diode Characteristic (T<sub>j</sub>=175°C)

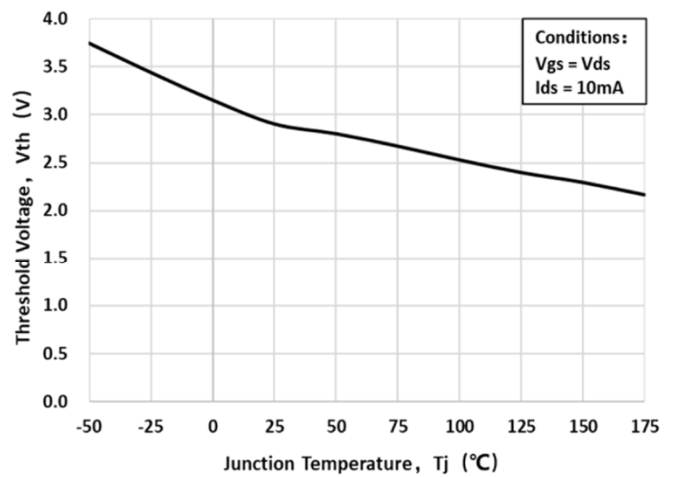


Fig 10: V<sub>TH</sub> Vs T<sub>J</sub> Temperature Characteristic

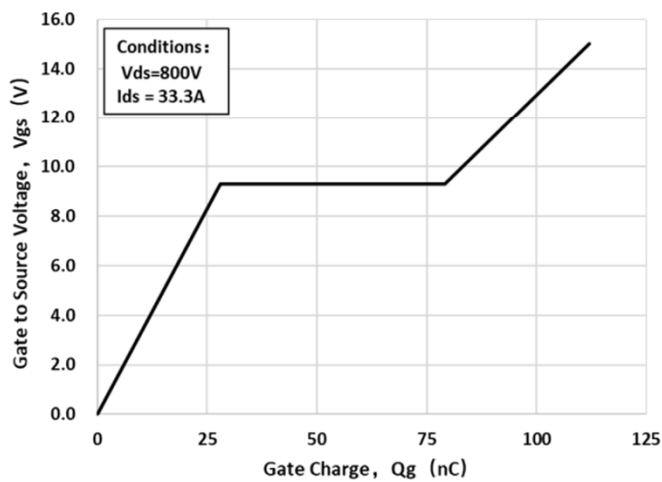


Fig 11: Gate Charge Characteristics

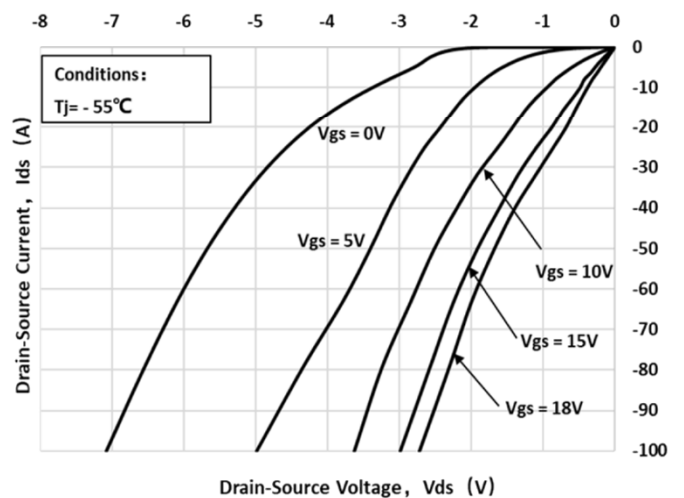
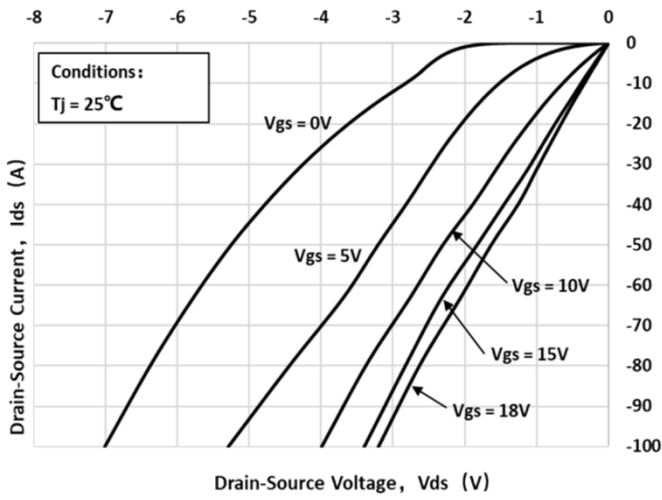
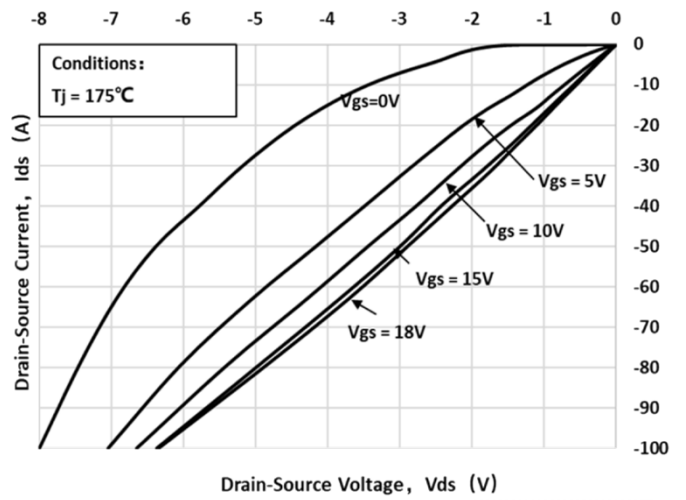


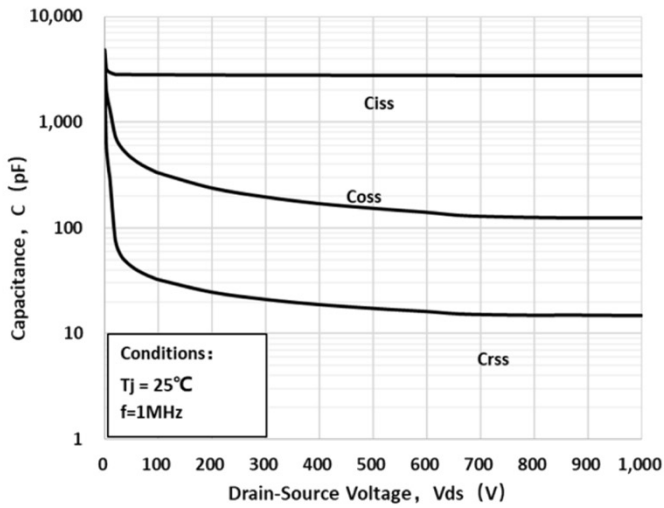
Fig 12: 3rd Quadrant Characteristic(T<sub>j</sub>=-55°C)



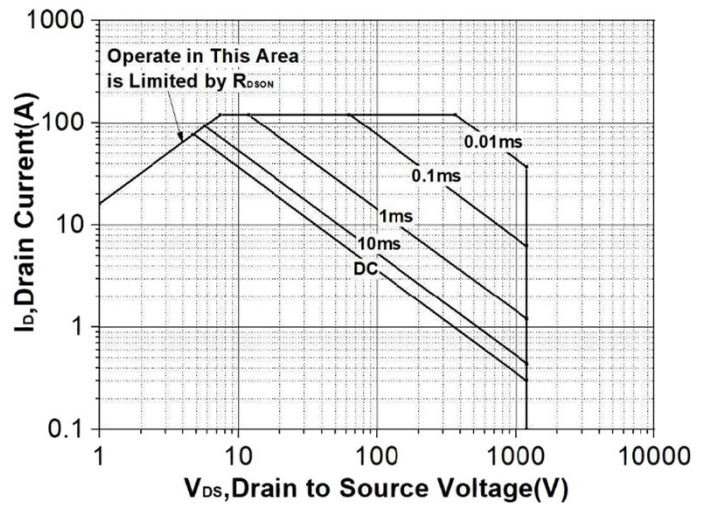
**Fig 13: 3rd Quadrant Characteristic(T<sub>J</sub>=25°C)**



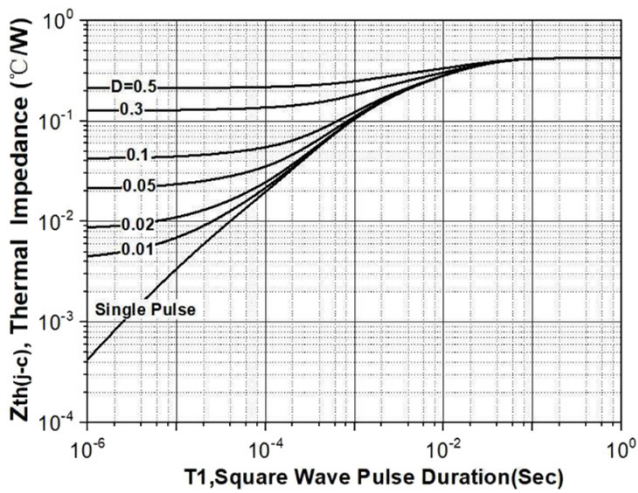
**Fig 14: 3rd Quadrant Characteristic(T<sub>J</sub>=175°C)**



**Fig 15: Capacitance Characteristic**

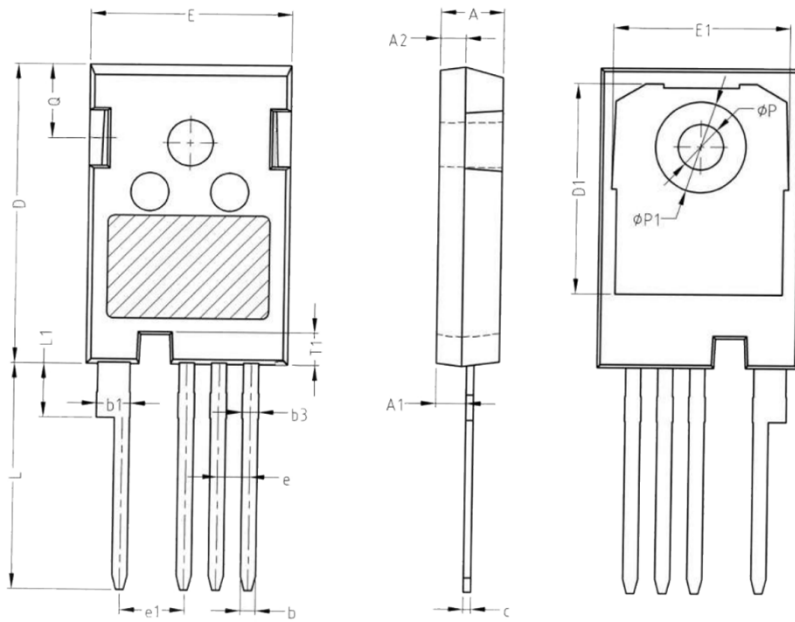


**Fig 16: Safe Operating Area**




**Fig 17: Transient Thermal Impedance**

## Product dimension (TO-247-4L)



Dim	Millimeters		Inches	
	Min	Max	Min	Max
A	4.80	5.20	0.189	0.205
A1	2.21	2.61	0.087	0.103
A2	1.80	2.20	0.071	0.087
b	1.06	1.36	0.042	0.054
b1	2.33	2.93	0.092	0.115
b3	1.07	1.60	0.042	0.063
c	0.51	0.75	0.020	0.030
D	23.30	23.60	0.917	0.929
D1	16.25	16.85	0.640	0.663
E	15.74	16.14	0.620	0.635
E1	13.72	14.32	0.540	0.564
T1	2.35	2.65	0.093	0.104
e	2.54 BSC		0.100 BSC	
e1	5.08 BSC		0.200 BSC	
Q	5.49	6.09	0.216	0.240
L	17.27	17.87	0.680	0.704
L1	3.99	4.39	0.157	0.173
φP	3.40	3.80	0.134	0.150
φP1	7.19 Ref.		0.283 Ref.	


**IMPORTANT NOTICE**

 and **Prisemi**<sup>®</sup> are registered trademarks of **Prisemi Electronics Co., Ltd** (Prisemi), Prisemi reserves the right to make changes without further notice to any products herein. Prisemi makes no warranty, representation or guarantee regarding the suitability of its products for any particular purpose, nor does Prisemi assume any liability arising out of the application or use of any product or circuit, and specifically disclaims any and all liability, including without limitation special, consequential or incidental damages. "Typical" parameters which may be provided in Prisemi data sheets and/or specifications can and do vary in different applications and actual performance may vary over time. All operating parameters, including "Typicals" must be validated for each customer application by customer's technical experts. Prisemi does not convey any license under its patent rights nor the rights of others. The products listed in this document are designed to be used with ordinary electronic equipment or devices, Should you intend to use these products with equipment or devices which require an extremely high level of reliability and the malfunction of with would directly endanger human life (such as medical instruments, aerospace machinery, nuclear-reactor controllers, fuel controllers and other safety devices), please be sure to consult with our sales representative in advance.

Website: <http://www.prisemi.com>

For additional information, please contact your local Sales Representative.

©Copyright 2009, Prisemi Electronics

 **Prisemi**<sup>®</sup> is a registered trademark of Prisemi Electronics.

All rights are reserved.