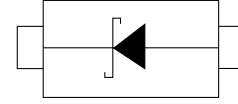

Feature

- Metal silicon junction, majority carrier conduction
- For surface mounted applications
- Low power loss, high efficiency
- High forward surge current capability
- For use in low voltage, high frequency inverters, free wheeling, and polarity protection applications

Mechanical Characteristics

- Case: SMBF
- Terminals : Solderable per MIL-STD-750, Method 2026
- Approx. Weight: 57mg /0.002oz

Absolute maximum rating@25°C

Ratings at 25°C ambient temperature unless otherwise specified. Single phase, half wave, 60Hz resistive or inductive load, for capacitive load, derate by 20 %

Parameter	Symbol	PSBDB F20V5	PSBDB F40V5	PSBDB F60V5	PSBDB F80V5	PSBDB F100V5	PSBDB F120V5	PSBDB F150V5	PSBDB F200V5	Units
Maximum Repetitive Peak Reverse Voltage	V_{RRM}	20	40	60	80	100	120	150	200	V
Maximum RMS voltage	V_{RMS}	14	28	42	56	70	84	105	140	V
Maximum DC Blocking Voltage	V_{DC}	20	40	60	80	100	120	150	200	V
Maximum Average Forward Rectified Current	$I_{F(AV)}$	5.0								A
Peak Forward Surge Current, 8.3ms Single Half Sine-wave Superimposed on Rated Load (JEDEC method)	I_{FSM}	120								A
Max Instantaneous Forward Voltage at 5 A	V_F	0.55		0.70		0.85				V

Absolute maximum rating@25°C

Parameter	Symbol	PSBDB F20V5	PSBDB F40V5	PSBDB F60V5	PSBDB F80V5	PSBDB F100V5	PSBDB F120V5	PSBDB F150V5	PSBDB F200V5	Units
Maximum DC Reverse Current Ta = 25°C at Rated DC Reverse Voltage Ta = 100°C	I _R	1.0 50								mA
Typical Junction Capacitance ¹⁾	C _j	800	500							pF
Typical Thermal Resistance ²⁾	R _{θJA}	45								°C/W
Operating Junction Temperature Range	T _j	-55~± 150								°C
Storage Temperature Range	T _{stg}	-55~+150								°C

Notes:

1. Measured at 1MHz and applied reverse voltage of 4 V D.C.
2. P.C.B. mounted with 0.5 X 0.5" (12.7 X 12.7 mm) copper pad areas.

Typical Characteristics

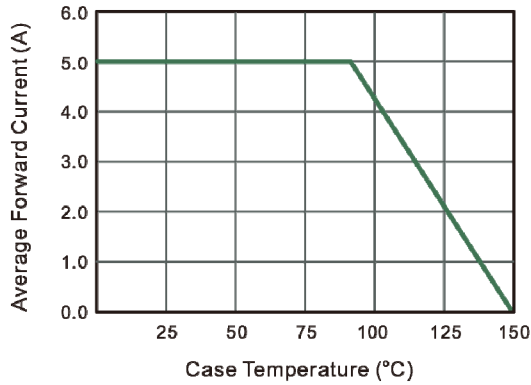

Fig.1 Forward Current Derating Curve

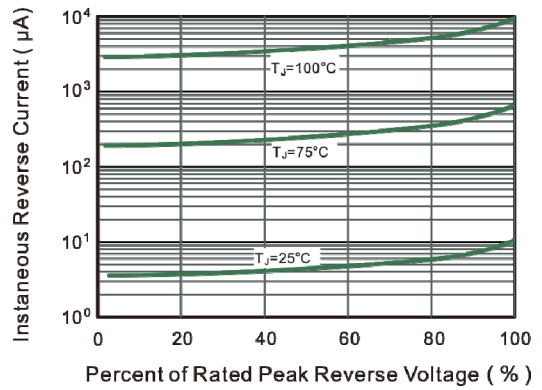

Fig.2 Typical Reverse Characteristics

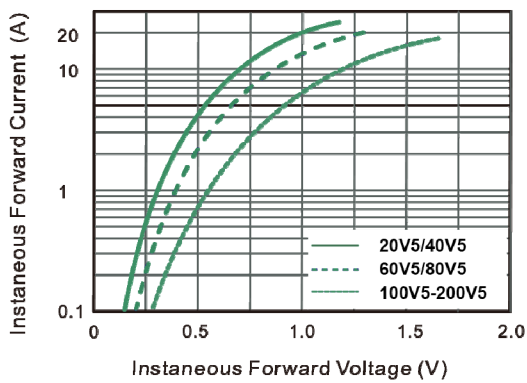

Fig.3 Typical Forward Characteristic

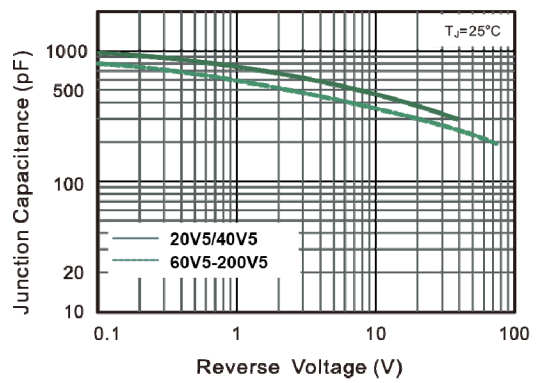

Fig.4 Typical Junction Capacitance

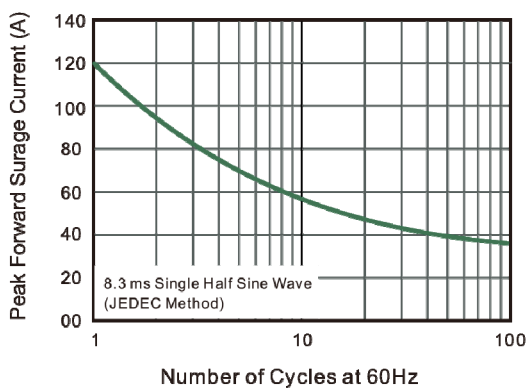

Fig.5 Maximum Non-Repetitive Peak Forward Surge Current

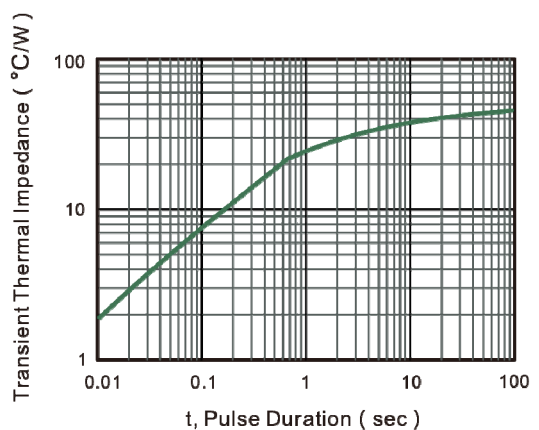
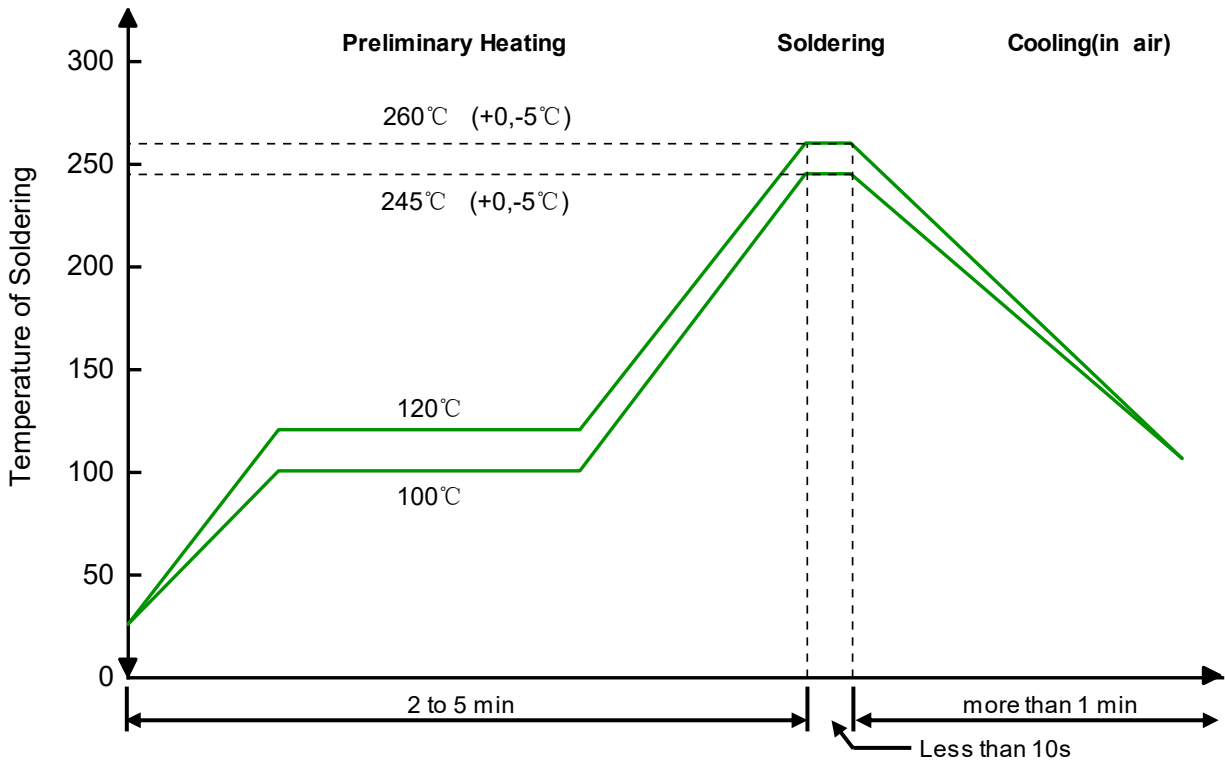

Fig.6- Typical Transient Thermal Impedance

Solder Reflow Recommendation



Remark: Pb free for 260°C; Pb for 245°C.

Product dimension (SMBF)

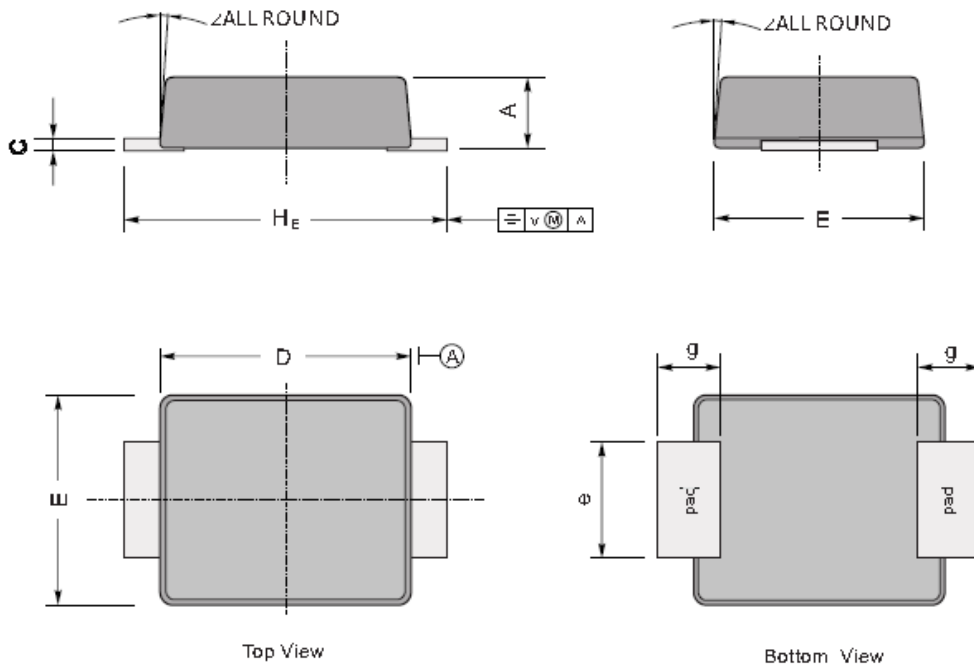

UNIT		A	C	D	E	He	e	g	z
mm	max	1.3	0.26	4.4	3.7	5.5	2.2	1.0	9°
	min	1.1	0.18	4.2	3.5	5.1	1.9		
mil	max	51	10	173	146	216	86	40	
	min	43	7	165	138	200	75		

The recommended mounting pad size

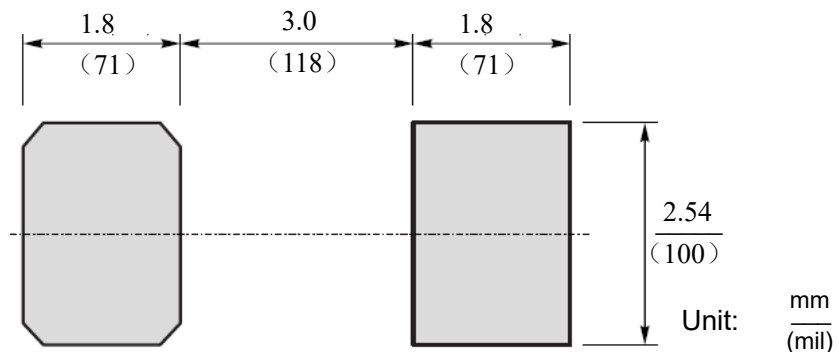

Ordering information

Device	Package	Shipping
PSBDBFXXXV5	SMBF (Pb-Free)	5000/ Tape & Reel

Load with information

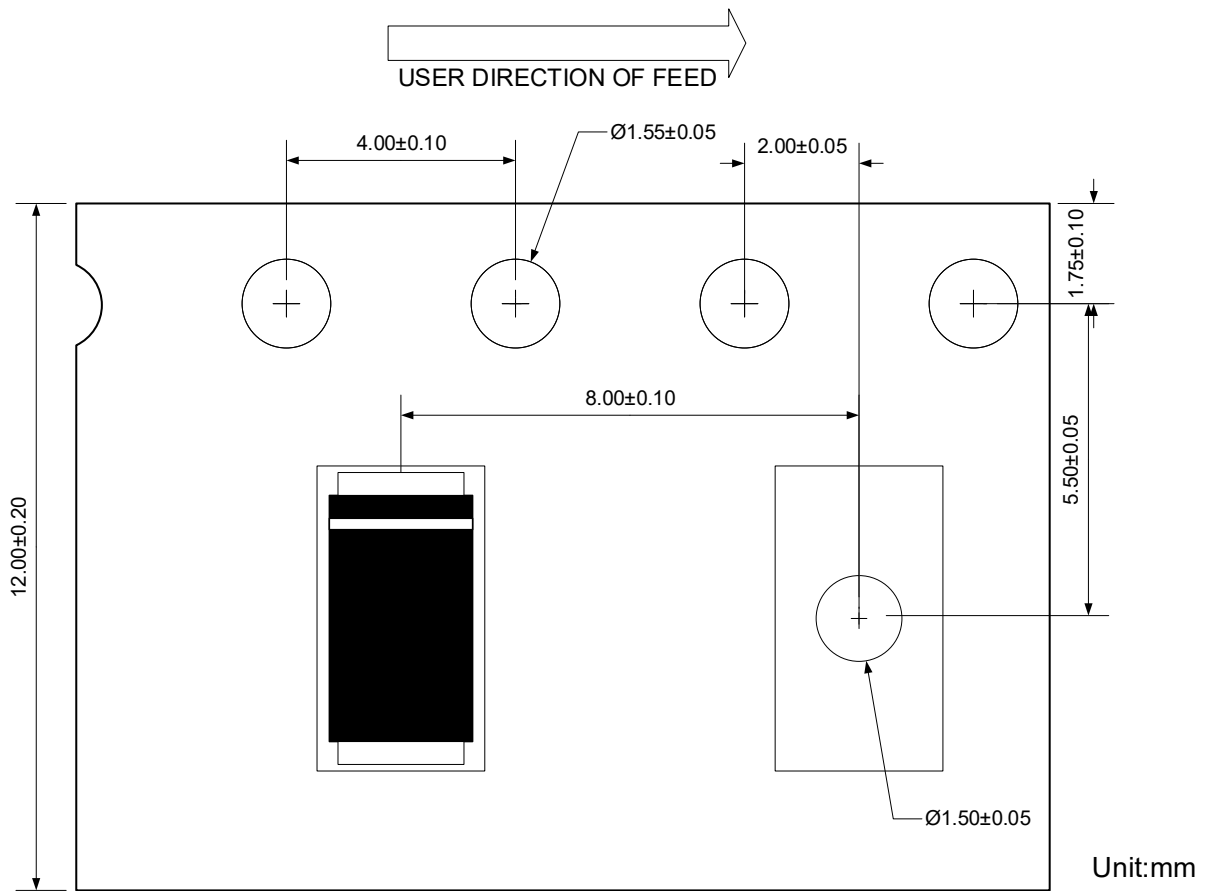

IMPORTANT NOTICE

 and **Prisemi**[®] are registered trademarks of **Prisemi Electronics Co., Ltd (Prisemi)** ,Prisemi reserves the right to make changes without further notice to any products herein. Prisemi makes no warranty, representation or guarantee regarding the suitability of its products for any particular purpose, nor does Prisemi assume any liability arising out of the application or use of any product or circuit, and specifically disclaims any and all liability, including without limitation special, consequential or incidental damages. “Typical” parameters which may be provided in Prisemi data sheets and/or specifications can and do vary in different applications and actual performance may vary over time. All operating parameters, including “Typicals” must be validated for each customer application by customer’s technical experts. Prisemi does not convey any license under its patent rights nor the rights of others. The products listed in this document are designed to be used with ordinary electronic equipment or devices, Should you intend to use these products with equipment or devices which require an extremely high level of reliability and the malfunction of with would directly endanger human life (such as medical instruments, aerospace machinery, nuclear-reactor controllers, fuel controllers and other safety devices), please be sure to consult with our sales representative in advance.

Website: <http://www.prisemi.com>

For additional information, please contact your local Sales Representative.

©Copyright 2009, Prisemi Electronics

 **Prisemi**[®] is a registered trademark of Prisemi Electronics.

All rights are reserved.