

650V Enhancement-mode GaN Transistor

Description

650V Normally-OFF GaN			
$V_{DS}(V)$	$R_{DS(on)}(m\Omega)$	$I_{DS}(A)$	$Q_G(nC)$
650	160	11	2.2

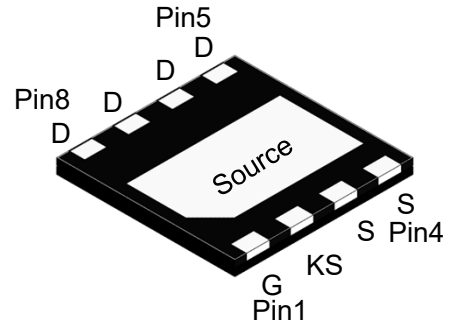

Feature

- Normally off power switch
- No reverse-recovery charge
- Ultra high switching frequency
- Low gate charge, low output charge
- Qualified for industrial applications according to JEDEC Standards
- Package:DFN5060-8L

Bottom View

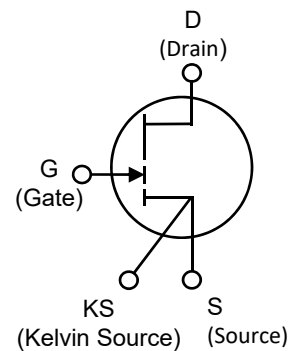

Circuit Diagram

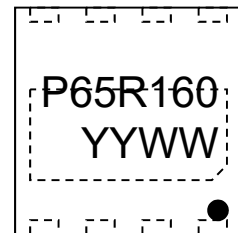

Pin4 Pin1
Marking (Top View)

Applications

- Fast charger
- Renewable energy
- Telecom and data-com
- Servo motors
- Industrial
- Automotive

Absolute maximum rating@25°C

Rating	Symbol	Value	Units
Drain-Source Voltage	V_{DS}	650	V
Drain-Source Voltage-transient ¹⁾	$V_{DS(transient)}$	750	V
Gate-Source Voltage	V_{GS}	-10 to +7	V
Drain Current-Continuous ²⁾	$T_C = 25^\circ C$	11	A
	$T_C = 125^\circ C$	5.0	A
Pulse Drain Current (pulse width: 300μs)	$T_C = 25^\circ C$	17	A
	$T_C = 125^\circ C$	10	
Maximum Power Dissipation	P_D	46	W
Junction and Storage Temperature Range	T_J, T_{STG}	-55~+150	°C

Notes:

1. Non-repetitive events, $T_{pulse} < 200\mu s$.
2. For increased stability at high current operation.

Thermal characteristics

Parameter	Symbol	Min.	Typ.	Max.	Units
Thermal Resistance, Junction - Case	$R_{\theta JC}$	-	2.72	-	$^{\circ}\text{C}/\text{W}$

Electrical characteristics per line@25°C (unless otherwise specified)

Parameter	Symbol	Conditions	Min.	Typ.	Max.	Units
Drain-Source Breakdown Voltage	BV_{DSS}	$V_{GS} = 0\text{V}$	650	-	-	V
Total Drain Leakage Current	I_{DSS}	$V_{DS} = 650\text{V}, V_{GS} = 0\text{V}$	-	1.0	20	μA
		$V_{DS} = 650\text{V}, V_{GS} = 0\text{V}, T_J = 150^{\circ}\text{C}$	-	10	50	
Gate Threshold Voltage	$V_{GS(th)}$	$V_{GS} = V_{DS}, I_D = 1\text{mA}$	1.8	2.5	3.5	V
		$V_{GS} = V_{DS}, I_D = 1\text{mA}, T_J = 150^{\circ}\text{C}$	-	2.8	-	
Gate-Source Leakage Current	I_{GSS}	$V_{GS} = 6\text{V}, V_{DS} = 0\text{V}$	-	60	-	μA
Static Drain-Source On-Resistance	$R_{DS(on)}$	$V_{GS} = 6\text{V}, I_D = 1\text{A}$	-	160	220	m Ω
		$V_{GS} = 6\text{V}, I_D = 1\text{A}, T_J = 150^{\circ}\text{C}$	-	330	-	
Input Capacitance	C_{iss}	$V_{DS} = 400\text{V}, V_{GS} = 0\text{V}, f = 1\text{MHz}$	-	66	-	pF
Output Capacitance	C_{oss}		-	26	-	
Reverse Transfer Capacitance	C_{rss}		-	0.9	-	
Effective Output Capacitance, Energy Related	$C_{oss(er)}$	$V_{GS} = 0\text{V}, V_{DS} = 0\text{V to } 400\text{V}$	-	48	-	pF
Effective Output Capacitance, Time Related	$C_{oss(tr)}$		-	68	-	
Output Charge	Q_{oss}	$V_{GS} = 0\text{V}, V_{DS} = 0\text{V to } 400\text{V}$	-	27	-	nC
Total Gate Charge	Q_g	$V_{GS} = 0 \text{ to } 6\text{V}, V_{DS} = 400\text{V}, I_D = 1\text{A}$	-	2.2	-	nC
Gate-Source Charge	Q_{gs}		-	0.2	-	
Gate-Drain Charge	Q_{gd}		-	0.8	-	
Reverse Device Characteristics						
Diode Forward Voltage	V_{SD}	$V_{GS} = 0\text{V}, I_S = 3\text{A}$	-	3.0	-	V
Reverse Recovery Charge	Q_{rr}	$I_S = 3\text{A}, V_{DS} = 400\text{V}$	-	0	-	nC

Typical Characteristics

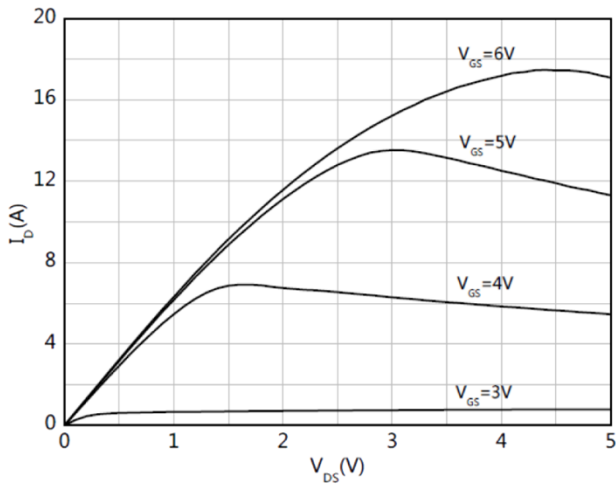

Figure 1. Typical Output Characteristics $T_j=25^\circ\text{C}$

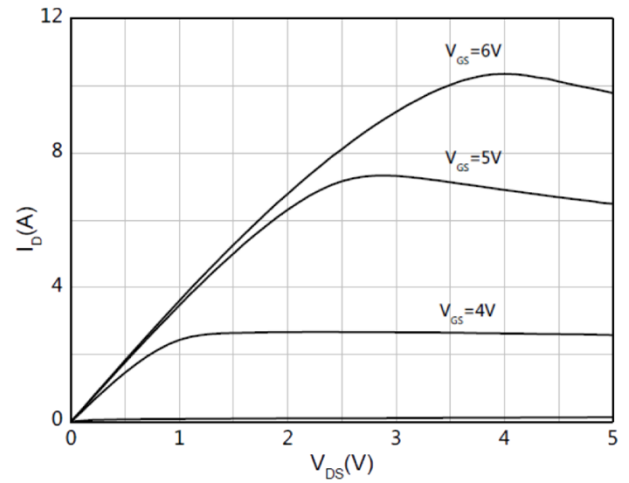

Figure 2. Typical Output Characteristics $T_j=125^\circ\text{C}$

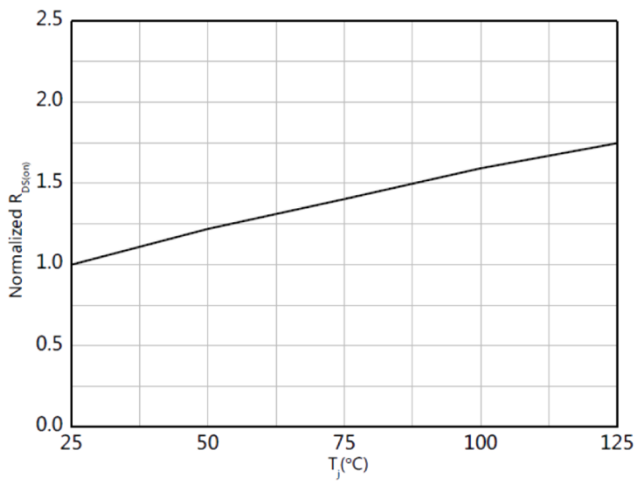

Figure 3. Drain-source On-state Resistance

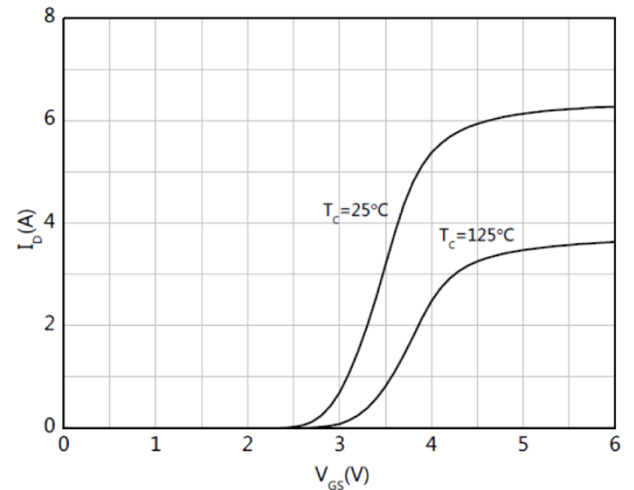

Figure 4. Typical Transfer Characteristics $V_{DS}=1\text{V}$

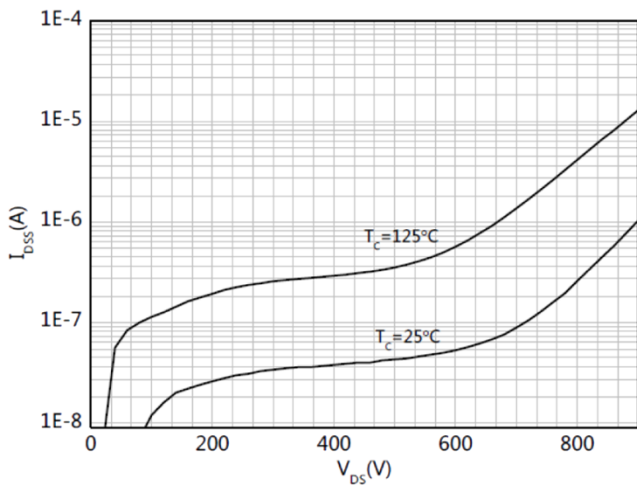

Figure 5. Drain-source Leakage Characteristics

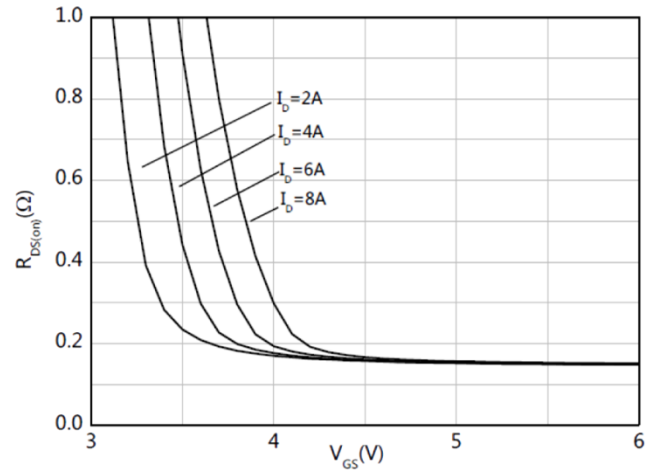

Figure 6. Typical On-state Resistance $T_j=25^\circ\text{C}$

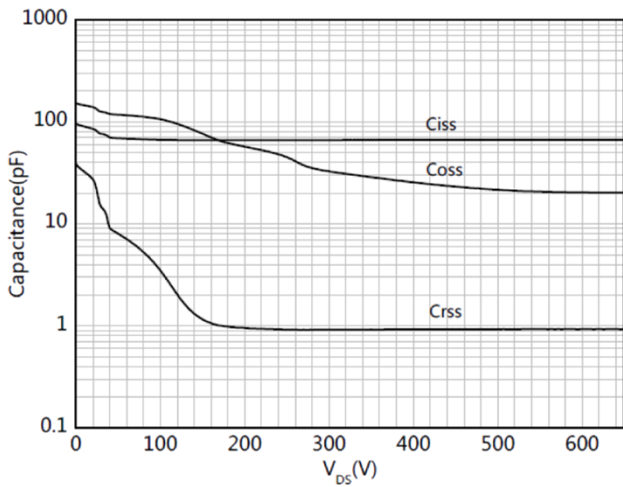

Figure 7. Typical Capacitance $f=1\text{MHz}$

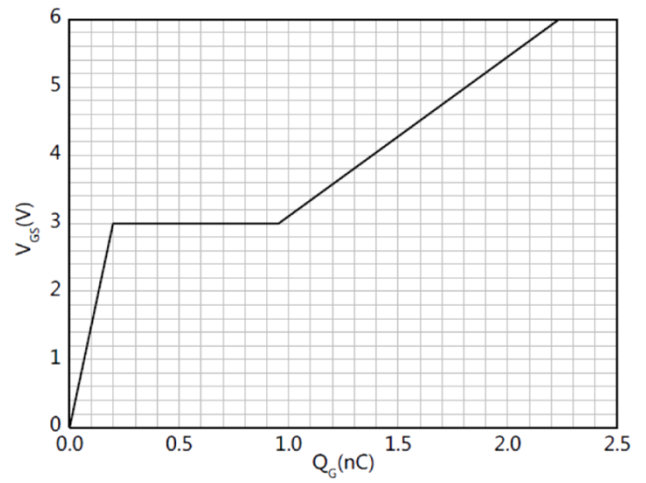

Figure 8. Typical Gate Charge ($V_{DS}=400\text{V}$, $I_D=1\text{A}$)

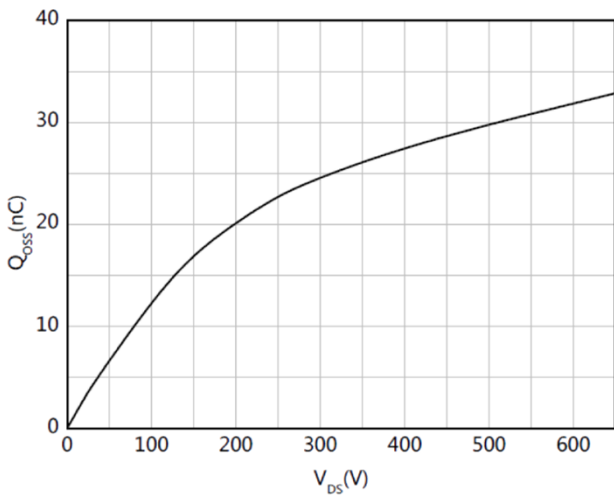

Figure 9. Typical Output Charge $f=1\text{MHz}$

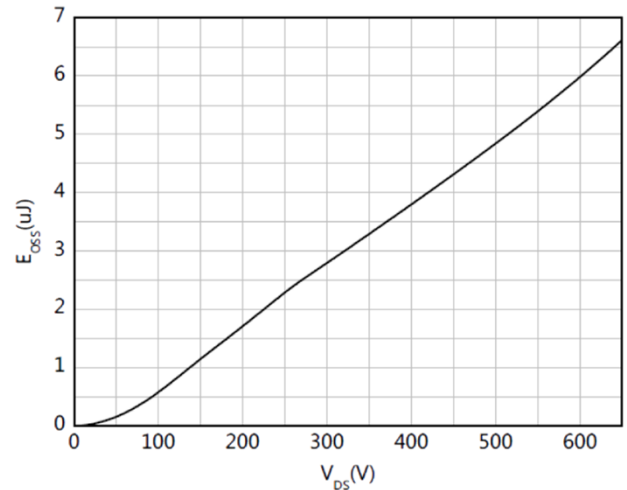

Figure 10. Typical Coss Stored Energy $f=1\text{MHz}$

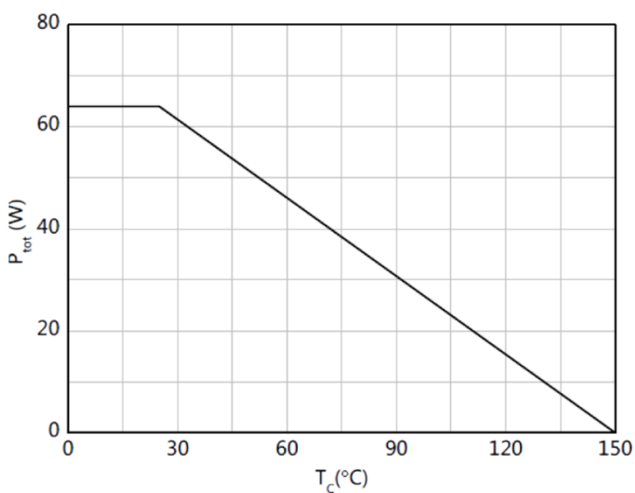

Figure 11. Power Dissipation

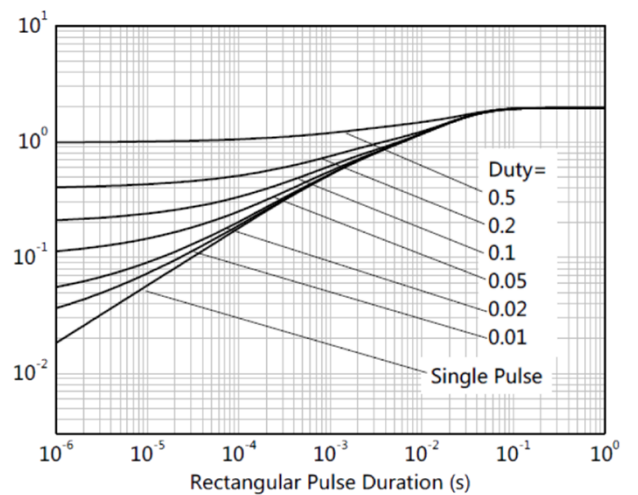

Figure 12. Transient Thermal Impedance

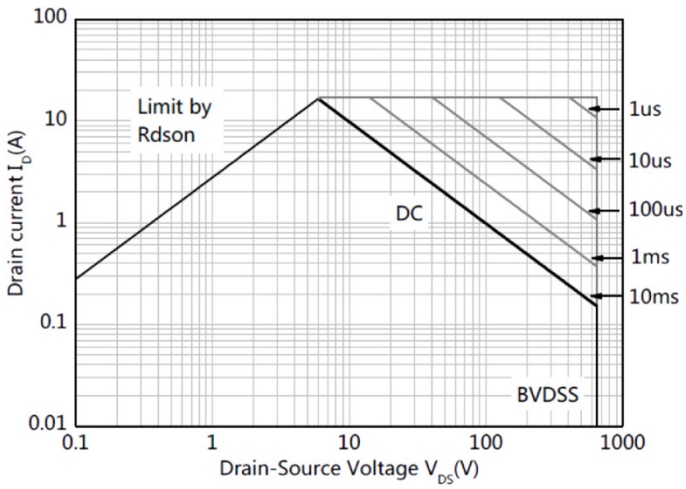

Figure 13. Safe Operation Area $T_c=25^\circ\text{C}$

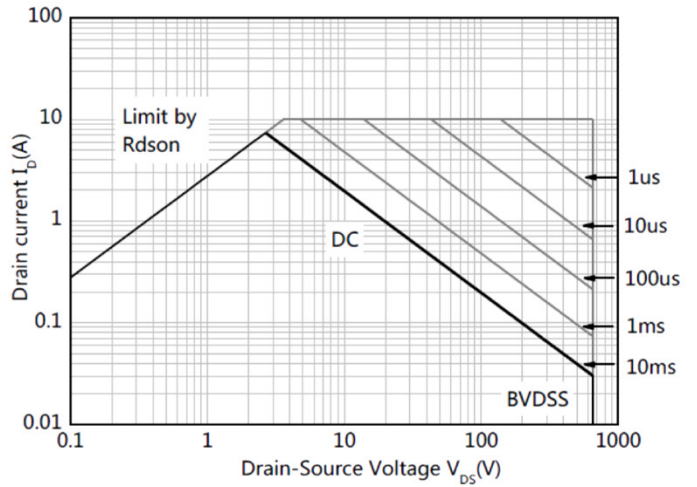

Figure 14. Safe Operation Area $T_c=125^\circ\text{C}$

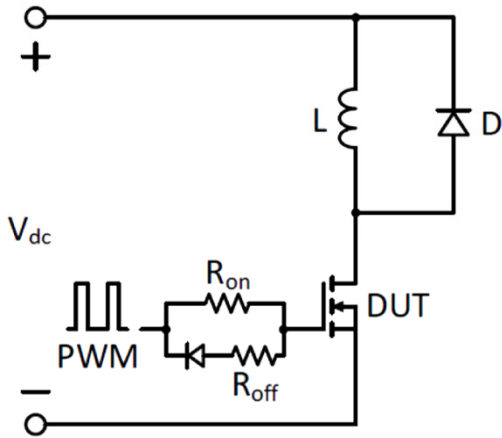

Figure 15. Switching Times With Inductive Load

$V_{DS}=400\text{V}$, $V_{GS}=0\text{V to }6\text{V}$, $I_D=3\text{A}$,
 $R_{G-on(ext)}=6.8\Omega$, $R_{G-off(ext)}=2.2\Omega$, $L=250\mu\text{H}$

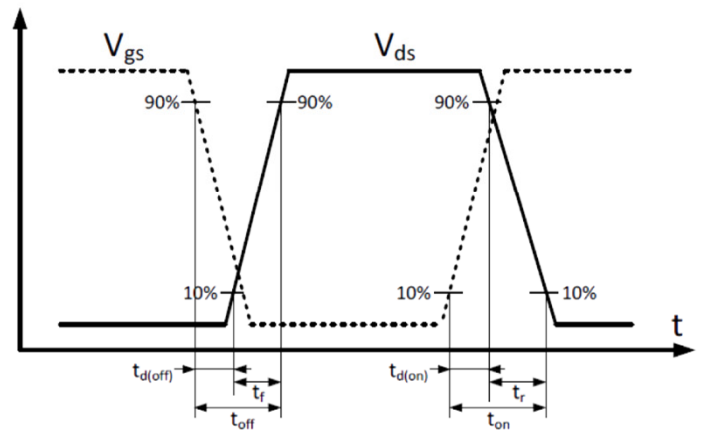
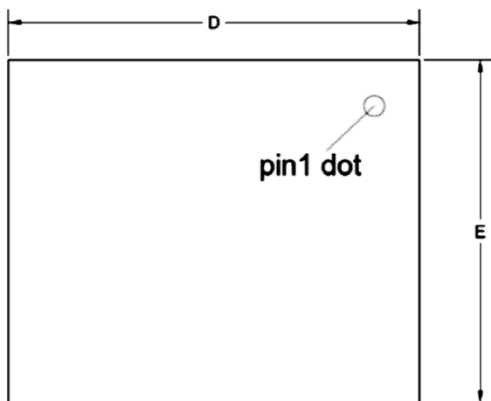

Figure 16. Switching Times With Waveform

Product Dimension (DFN5060-8L)

Top view



Bottom view

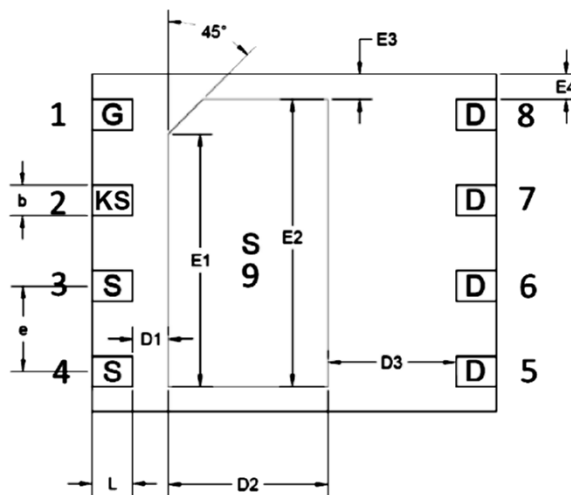

Side view(left/right)

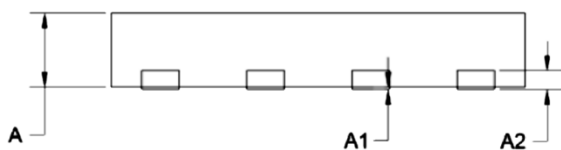

Dim	Millimeters		Inches		Dim	Millimeters		Inches	
	Min	Max	Min	Max		Min	Max	Min	Max
A	0.85	0.95	0.033	0.037	E1	3.65	3.85	0.144	0.152
A1	0.00	0.05	0.000	0.002	E2	4.16	4.36	0.164	0.172
A2	0.203 Ref.		0.008 Ref.		E3	0.27	0.47	0.011	0.019
D	5.90	6.10	0.232	0.240	E4	0.27	0.47	0.011	0.019
E	4.90	5.10	0.193	0.201	b	0.40	0.50	0.016	0.020
D1	0.43	0.63	0.017	0.025	e	1.17	1.37	0.046	0.054
D2	2.27	2.47	0.089	0.097	L	0.50	0.70	0.020	0.028
D3	1.80	2.00	0.071	0.079					

IMPORTANT NOTICE

 and **Prisemi**[®] are registered trademarks of **Prisemi Electronics Co., Ltd** (Prisemi), Prisemi reserves the right to make changes without further notice to any products herein. Prisemi makes no warranty, representation or guarantee regarding the suitability of its products for any particular purpose, nor does Prisemi assume any liability arising out of the application or use of any product or circuit, and specifically disclaims any and all liability, including without limitation special, consequential or incidental damages. "Typical" parameters which may be provided in Prisemi data sheets and/or specifications can and do vary in different applications and actual performance may vary over time. All operating parameters, including "Typicals" must be validated for each customer application by customer's technical experts. Prisemi does not convey any license under its patent rights nor the rights of others. The products listed in this document are designed to be used with ordinary electronic equipment or devices, Should you intend to use these products with equipment or devices which require an extremely high level of reliability and the malfunction of with would directly endanger human life (such as medical instruments, aerospace machinery, nuclear-reactor controllers, fuel controllers and other safety devices), please be sure to consult with our sales representative in advance.

Website: <http://www.prisemi.com>

For additional information, please contact your local Sales Representative.

©Copyright 2009, Prisemi Electronics

 **Prisemi**[®] is a registered trademark of Prisemi Electronics.

All rights are reserved.