

## Description

The PSMTO06R3L uses split gate trench technology to provide excellent  $R_{DS(ON)}$  low gate charge. This device is suitable for power management and high efficiency applications at high switching frequencies

### MOSFET Product Summary

$V_{DS}(V)$	$R_{DS(on)}(m\Omega)$	$I_D(A)$	
60	3.3@ $V_{GS} = 10V$	Silicon Limited $T_C=25^\circ C$	158
		Silicon Limited $T_C=100^\circ C$	100
		Package Limited $T_C=25^\circ C$	100

## Feature

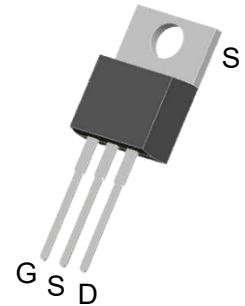
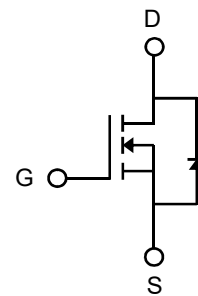
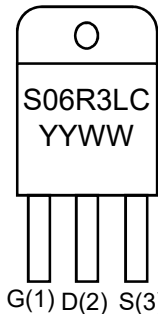
- Low  $R_{DS(ON)}$  - Ensures On-State Losses are Minimized
- Excellent  $Q_{gd} \times R_{DS(ON)}$  Product(FOM)
- Advanced Technology for DC-DC Converts
- Small Form Factor Thermally Efficient Package  
Enables Higher Density End Products
- 100% UIS (Avalanche) Rated
- Lead-Free Finish ; RoHS Compliant
- Halogen and Antimony Free. "Green" Device

## Applications

- PWM applications
- Load switch
- Power management
- DC-DC Converters
- Wireless Chargers

## Absolute maximum rating@25°C

Rating		Symbol	Value	Units
Drain-Source Voltage		$V_{DS}$	60	V
Gate-Source Voltage		$V_{GS}$	$\pm 20$	V
Drain Current-Continuous	Silicon Limited $T_C=25^\circ C$	$I_D$	158	A
	Silicon Limited $T_C=100^\circ C$		100	
	Package Limited $T_C=25^\circ C$		100	
Pulsed Drain Current <sup>1)</sup>		$I_{DM}$	380	A
Total Power Dissipation <sup>2)</sup>		$P_D$	92	W
Avalanche Current <sup>5)</sup>		$I_{AS}$	75.5	A
Avalanche Energy <sup>5)</sup>		$E_{AS}$	285	mJ
Thermal Resistance , Junction-case		$R_{\theta JC}$	1.36	$^\circ C/W$
Thermal Resistance Junction-to-Ambient @ Steady State <sup>2)</sup>		$R_{\theta JA}$	43.65	$^\circ C/W$
Junction and Storage Temperature Range		$T_J, T_{STG}$	-55~+150	$^\circ C$


**TO-220 (Top View)**

**Circuit Diagram**

**Marking (Top View)**

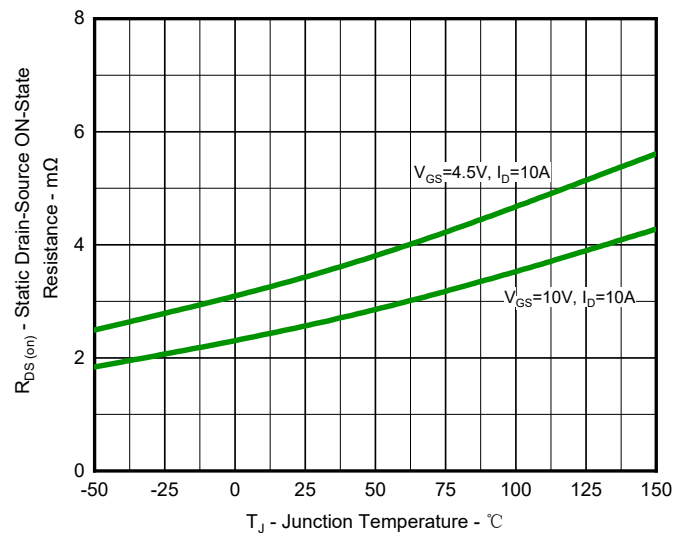
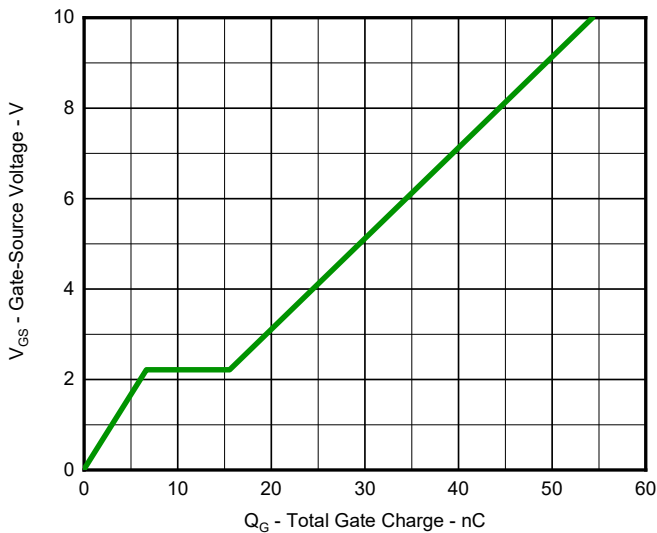
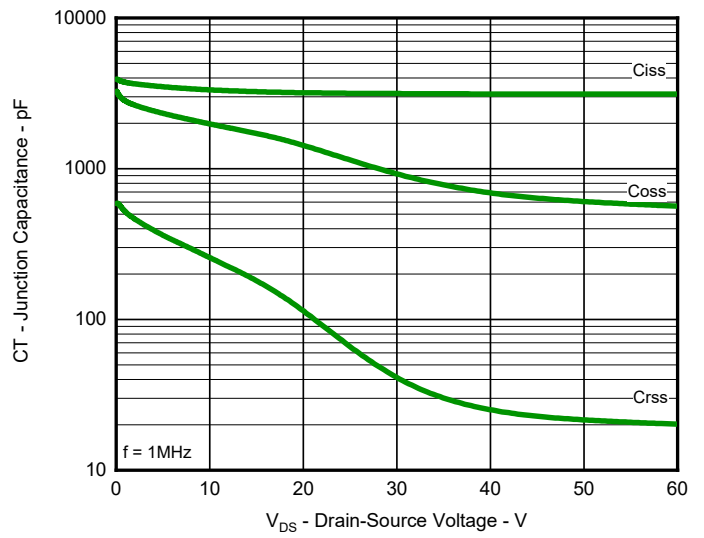
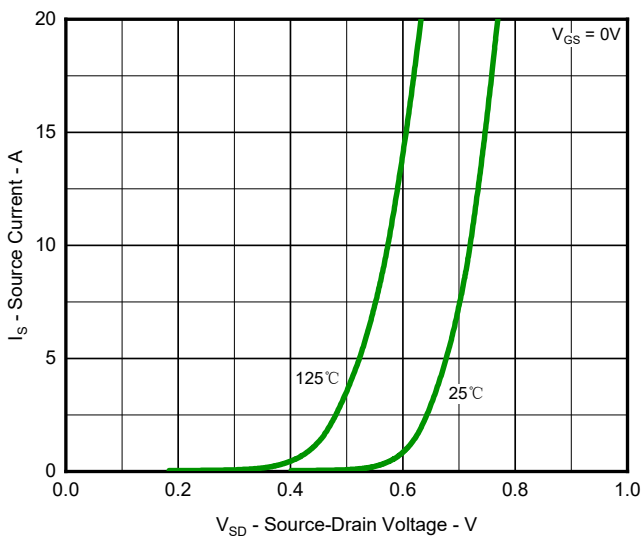
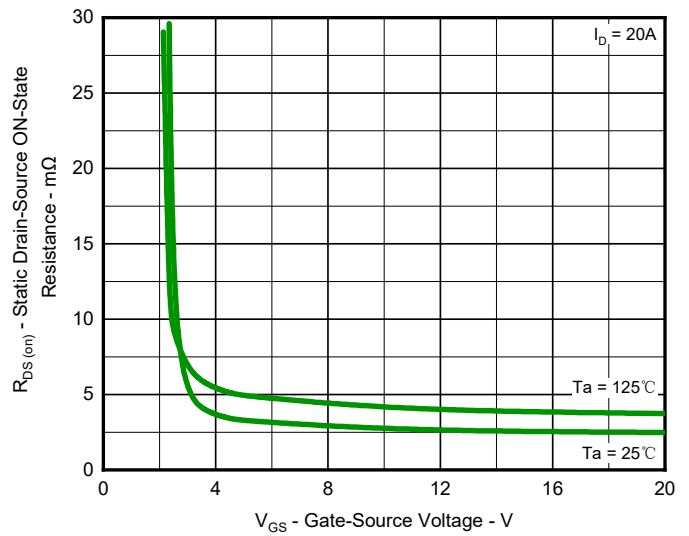
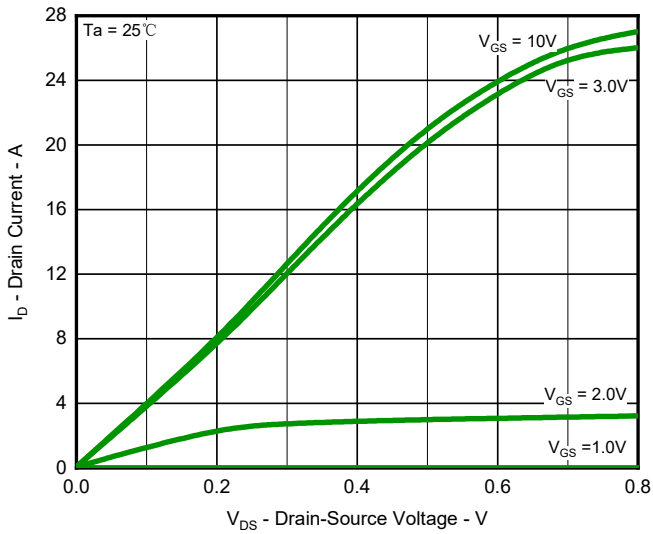
## Electrical characteristics per line@25°C (unless otherwise specified)

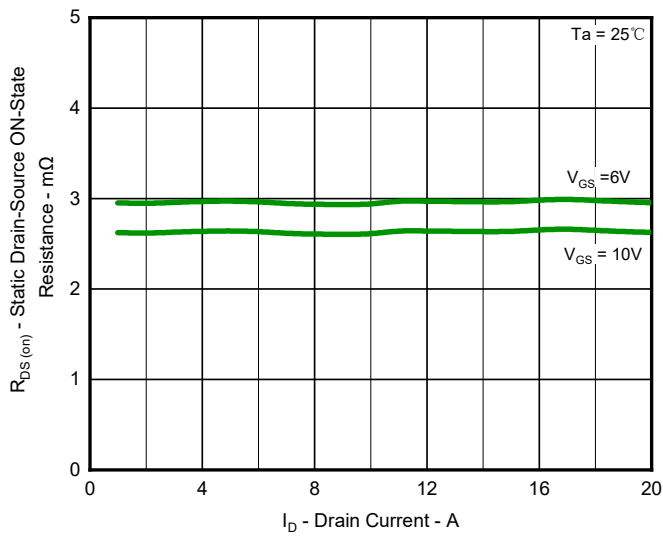
Parameter	Symbol	Conditions	Min.	Typ.	Max.	Units
Off Characteristics						
Drain-Source Breakdown Voltage	$BV_{DSS}$	$V_{GS}=0V, I_D=250\mu A$	60	-	-	V
Zero Gate Voltage Drain Current	$I_{DSS}$	$V_{DS}=60V, V_{GS}=0V$	-	-	1	$\mu A$
Gate-Body Leakage Current	$I_{GSS}$	$V_{GS}=\pm 20V, V_{DS}=0V$	-	-	$\pm 100$	nA
On Characteristics <sup>3)</sup>						
Gate Threshold Voltage	$V_{GS(th)}$	$V_{DS}=V_{GS}, I_D=250\mu A$	1.0	1.5	2.0	V
Static Drain-Source On-Resistance	$R_{DS(ON)}$	$V_{GS}=10V, I_D=20A$	-	3.3	4.5	m $\Omega$
		$V_{GS}=4.5V, I_D=20A$	-	4.5	5.5	
Dynamic Parameters <sup>4)</sup>						
Input Capacitance	$C_{iss}$	$V_{DS}=30V, V_{GS}=0V, f=1MHz$	-	3122	-	pF
Output Capacitance	$C_{oss}$		-	888	-	
Reverse Transfer Capacitance	$C_{rss}$		-	36	-	
Switching Parameters <sup>4)</sup>						
Turn-on Delay Time	$t_{d(on)}$	$V_{DS}=30V, V_{GS}=10V, R_G=10\Omega, I_D=20A$	-	8.7	-	ns
Turn-on Rise Time	$t_r$		-	14.5	-	
Turn-Off Delay Time	$t_{d(off)}$		-	109.2	-	
Turn-Off Fall Time	$t_f$		-	46.5	-	
Total Gate Charge	$Q_g$	$V_{DS}=30V, I_D=20A, V_{GS}=10V$	-	54.2	-	nC
Gate-Source Charge	$Q_{gs}$		-	6.7	-	
Gate-Drain Charge	$Q_{gd}$		-	8.9	-	
Gate Resistance	$R_g$	$V_{GS}=0V, V_{DS}=0V, f=1MHz$	-	1.36	-	$\Omega$
Drain-Source Diode Characteristics						
Diode Forward Voltage <sup>3)</sup>	$V_{SD}$	$V_{GS}=0V, I_S=20A$	-	0.83	1.1	V

Notes:

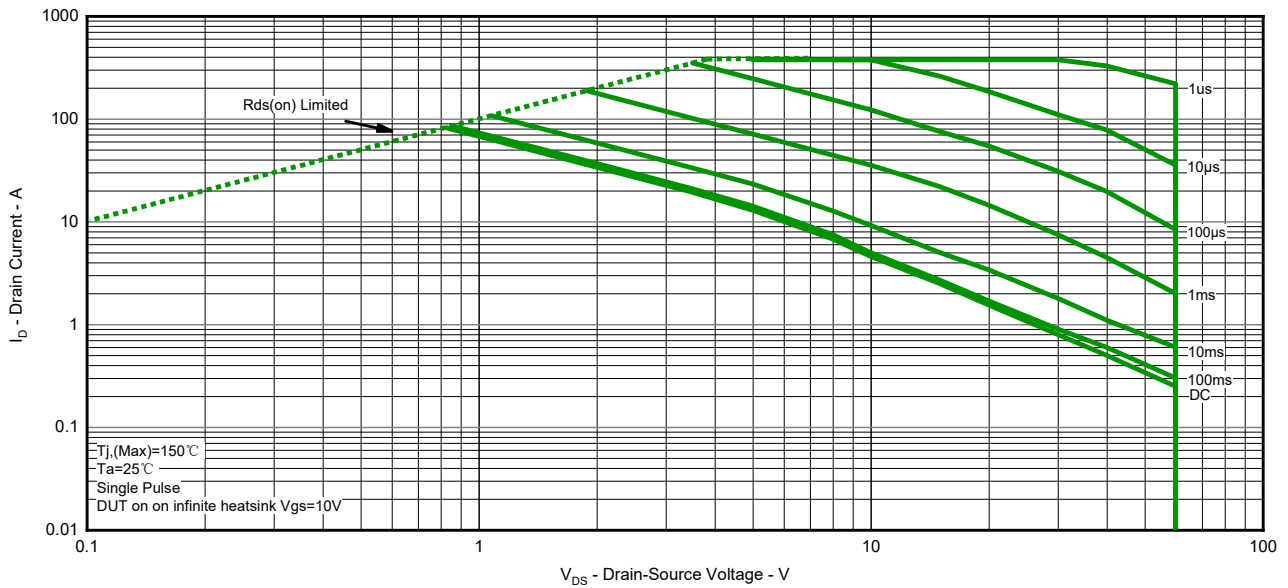
1. Repetitive Rating: Pulse width limited by maximum junction temperature.
2. Device mounted on FR-4 substrate PC board, 2oz copper, with 1inch square copper pad layout.
3. Pulse Test: Pulse Width  $\leq 300\mu s$ , Duty Cycle  $\leq 2\%$ .
4. Guaranteed by design, not subject to production.
5. This single-pulse measurement was taken under the following condition ( $L=100\mu H, V_{GS}=10V, V_{DS}=50V$ ) while it's value is limited by  $T_{J,Max}=150^\circ C$ .

## Typical Characteristics

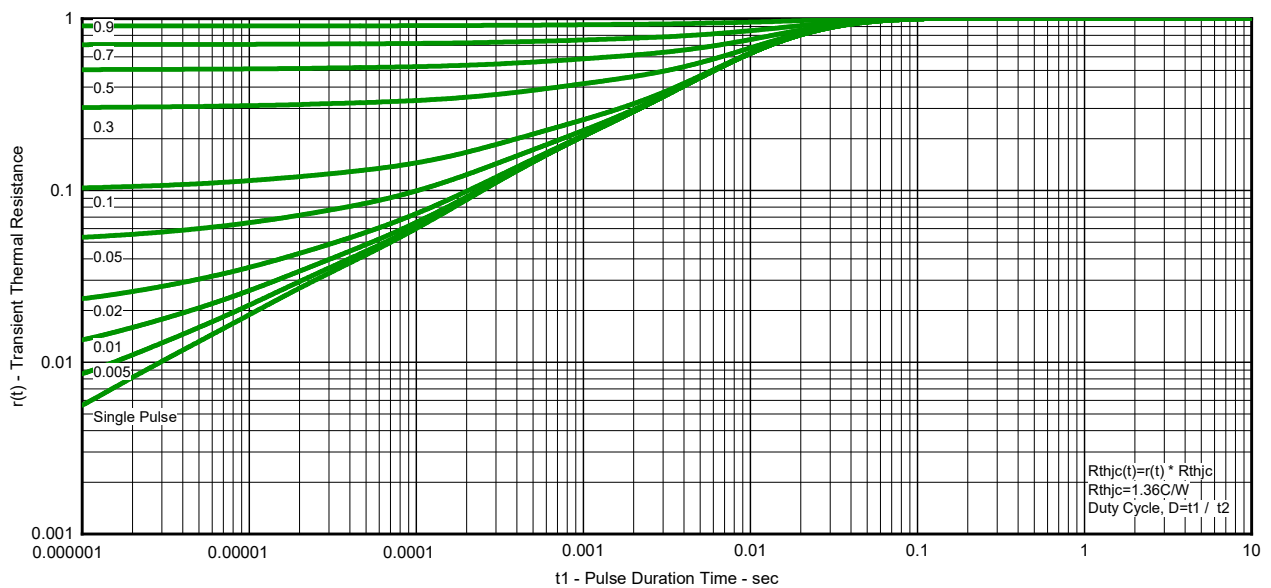




**Fig.7 Typical On-Resistance vs Drain Current**

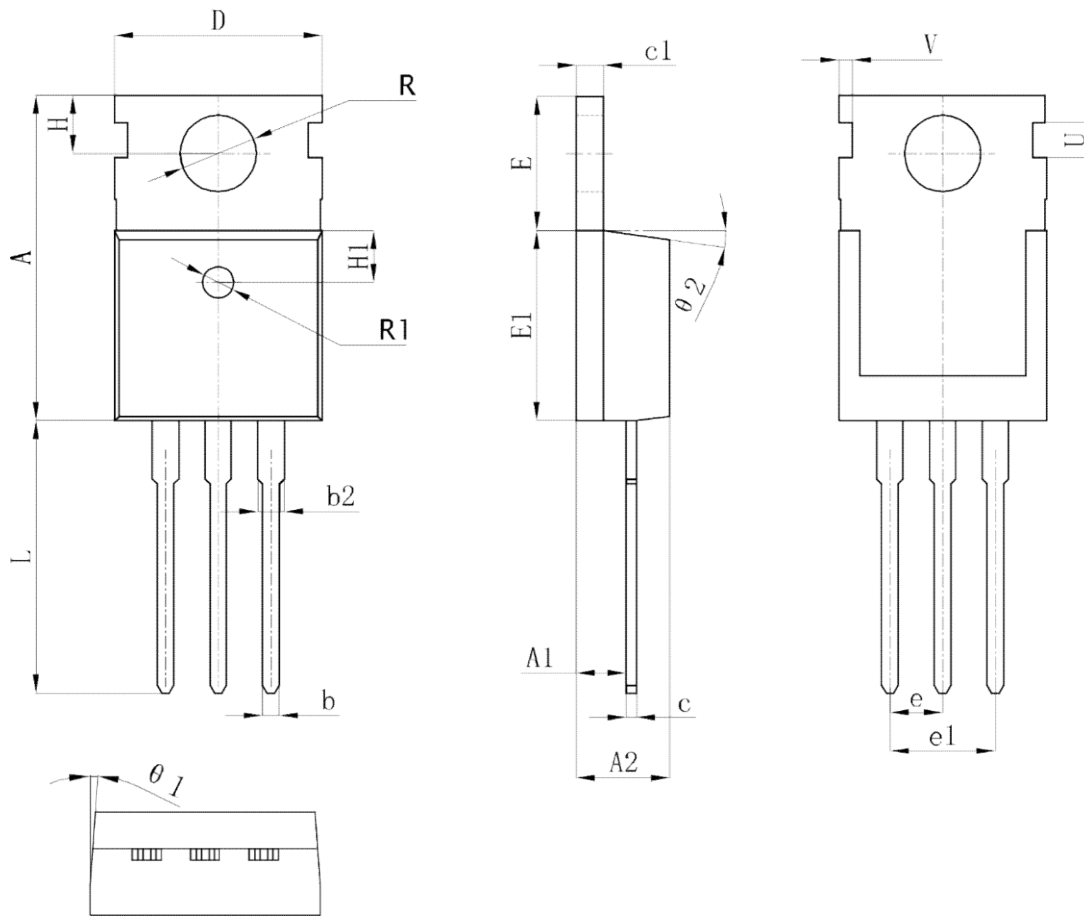


**Fig.8 Safe Operation Area**




**Fig.9 Transient Thermal Resistance**

## Product Dimension (TO-220)



Dim	Millimeters		Inches		Dim	Millimeters		Inches	
	Min	Max	Min	Max		Min	Max	Min	Max
A	15.40	15.80	0.606	0.622	e1	4.84	5.32	0.191	0.209
A1	2.35	2.50	0.093	0.098	H	2.73	2.87	0.107	0.113
A2	4.40	4.70	0.173	0.185	H1	2.40	2.60	0.094	0.102
b	0.70	0.90	0.028	0.035	L	13.02	13.72	0.513	0.540
b2	1.18	1.44	0.046	0.057	R	3.50	3.63	0.138	0.143
c	0.48	0.56	0.019	0.022	R1	1.40	1.60	0.055	0.063
c1	1.29	1.32	0.051	0.052	U	1.65	1.85	0.065	0.073
D	9.80	10.20	0.386	0.402	V	0.58	0.78	0.023	0.031
E	6.40	6.60	0.252	0.260	$\theta 1$	2°	3°	2°	3°
E1	9.00	9.20	0.354	0.362	$\theta 2$	6.5°	7.5°	6.5°	7.5°
e	2.42	2.66	0.095	0.105					


**IMPORTANT NOTICE**

 and **Prisemi**<sup>®</sup> are registered trademarks of **Prisemi Electronics Co., Ltd** (Prisemi), Prisemi reserves the right to make changes without further notice to any products herein. Prisemi makes no warranty, representation or guarantee regarding the suitability of its products for any particular purpose, nor does Prisemi assume any liability arising out of the application or use of any product or circuit, and specifically disclaims any and all liability, including without limitation special, consequential or incidental damages. “Typical” parameters which may be provided in Prisemi data sheets and/or specifications can and do vary in different applications and actual performance may vary over time. All operating parameters, including “Typicals” must be validated for each customer application by customer’s technical experts. Prisemi does not convey any license under its patent rights nor the rights of others. The products listed in this document are designed to be used with ordinary electronic equipment or devices, Should you intend to use these products with equipment or devices which require an extremely high level of reliability and the malfunction of which would directly endanger human life (such as medical instruments, aerospace machinery, nuclear-reactor controllers, fuel controllers and other safety devices), please be sure to consult with our sales representative in advance.

Website: <http://www.prisemi.com>

For additional information, please contact your local Sales Representative.

©Copyright 2009, Prisemi Electronics

 **Prisemi**<sup>®</sup> is a registered trademark of Prisemi Electronics.

All rights are reserved.