

Description

The PSM8N10R4L uses split gate trench technology to provide excellent $R_{DS(on)}$ low gate charge. This device is suitable for power management and high efficiency applications at high switching frequencies applications.

MOSFET Product Summary

$V_{DS}(V)$	$R_{DS(on)}(m\Omega)$	$I_D(A)$
100	3.6@ $V_{GS} = 10V$	120
	6.1@ $V_{GS} = 4.5V$	

Feature

- Low $R_{DS(on)}$ - Ensures On-State Losses are Minimized
- Excellent $Q_{gd} \times R_{DS(on)}$ Product(FOM)
- Advanced Technology for DC-DC Converts
- Small Form Factor Thermally Efficient Package
Enables Higher Density End Products
- 100% UIS (Avalanche) Rated
- Lead-Free Finish ; RoHS Compliant
- Halogen and Antimony Free. "Green" Device

Applications

- PWM applications
- Load switch
- Power management
- DC-DC Converters
- Wireless Chargers

Absolute maximum rating@25°C

Rating	Symbol	Value	Units
Drain-Source Voltage	V_{DS}	100	V
Gate-Source Voltage	V_{GS}	± 20	V
Drain Current-Continuous ¹⁾	I_D	$T_C=25^\circ C$	120
		$T_C=100^\circ C$	76
Pulsed Drain Current ²⁾	I_{DM}	480	A
Total Power Dissipation ³⁾	P_D	131.6	W
Avalanche Current ⁴⁾	I_{AS}	91	A
Avalanche Energy ⁴⁾	E_{AS}	418	mJ
Thermal Resistance , Junction-case ⁵⁾	$R_{\theta JC}$	0.96	$^\circ C/W$
Thermal Resistance Junction-to-Ambient ⁶⁾	$R_{\theta JA}$	44.4	$^\circ C/W$
Junction and Storage Temperature Range	T_J, T_{STG}	-55~+150	$^\circ C$

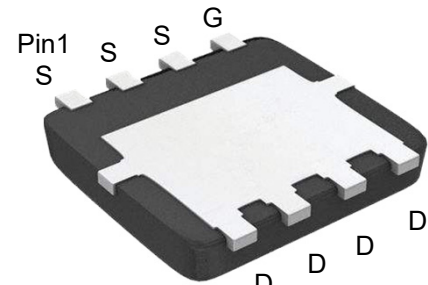

PDFN5060-8L
(Bottom View)

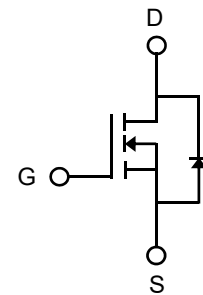

Circuit Diagram

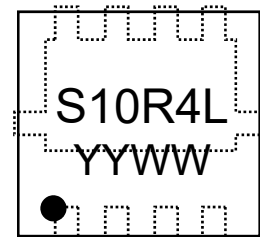

Pin1
Marking (Top View)

Electrical characteristics per line@25°C (unless otherwise specified)

Parameter	Symbol	Conditions	Min.	Typ.	Max.	Units
Off Characteristics						
Drain-Source Breakdown Voltage	BV_{DSS}	$V_{GS} = 0V, I_D = 250\mu A$	100	110	-	V
Zero Gate Voltage Drain Current	I_{DSS}	$V_{DS} = 100V, V_{GS} = 0V$	-	-	1.0	μA
Gate-Body Leakage Current	I_{GSS}	$V_{GS} = \pm 20V, V_{DS} = 0V$	-	-	± 100	nA
On Characteristics						
Gate Threshold Voltage	$V_{GS(th)}$	$V_{DS} = V_{GS}, I_D = 250\mu A$	1.4	2.0	2.4	V
Drain-Source On-State Resistance	$R_{DS(ON)}$	$V_{GS} = 10V, I_D = 40A$	-	3.6	5.0	m Ω
		$V_{GS} = 4.5V, I_D = 30A$	-	6.1	7.5	
Dynamic Characteristics⁷⁾						
Input Capacitance	C_{iss}	$V_{DS} = 50V, V_{GS} = 0V,$ $f = 1.0MHz$	-	4476	-	pF
Output Capacitance	C_{oss}		-	623	-	
Reverse Transfer Capacitance	C_{rss}		-	22	-	
Switching Characteristics⁷⁾						
Turn-on Delay Time	$t_{d(on)}$	$V_{DS} = 50V, V_{GS} = 10V,$ $R_G = 10\Omega, I_D = 15A$	-	17.3	-	ns
Turn-on Rise Time	t_r		-	26.9	-	
Turn-Off Delay Time	$t_{d(off)}$		-	103.7	-	
Turn-Off Fall Time	t_f		-	51.6	-	
Total Gate Charge	Q_g	$V_{DS} = 50V, V_{GS} = 10V,$ $I_D = 40A$	-	60.2	-	nC
Gate-Source Charge	Q_{gs}		-	13.7	-	
Gate-Drain Charge	Q_{gd}		-	8.8	-	
Gate Resistance	R_g	$V_{GS}=0V, V_{DS}=0V, f=1MHz$	-	2.7	-	Ω
Drain-Source Diode Characteristics						
Diode Forward Voltage	V_{SD}	$V_{GS} = 0V, I_S = 1A$	-	0.7	1.4	V

Notes:

1. Computed continuous current assumes the condition of T_{J_Max} while the actual continuous current depends on the thermal & electro-mechanical application board design.
2. Repetitive Rating: Pulse width limited by maximum junction temperature($T_{J_Max}=150^\circ C$).
3. Pulse Test: Pulse Width $\leq 300\mu s$, Duty Cycle $\leq 2\%$.
4. This single-pulse measurement was taken under the following condition ($L=100\mu H, V_{GS}=10V, V_{DS}=50V$)while it's value is limited by $T_{J_Max}=150^\circ C$.
5. Device mounted on infinite heatsink.
6. Device mounted on FR-4 substrate PC board, 2oz copper, with 1inch square copper pad layout.
7. Guaranteed by design, not subject to production.

Typical Characteristics

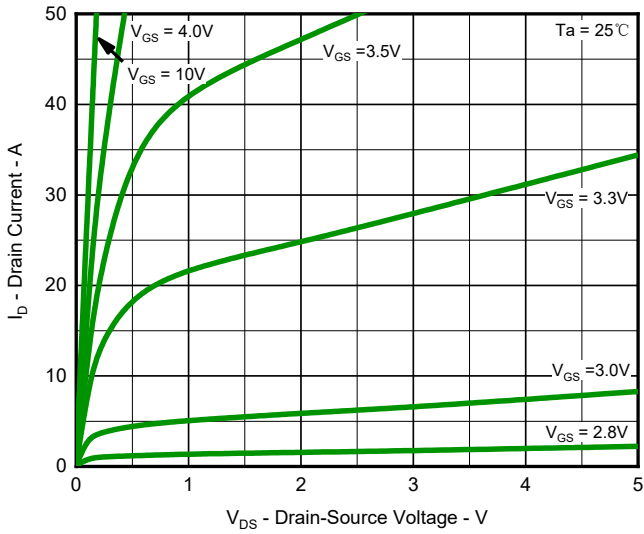

Fig.1 Output Characteristics

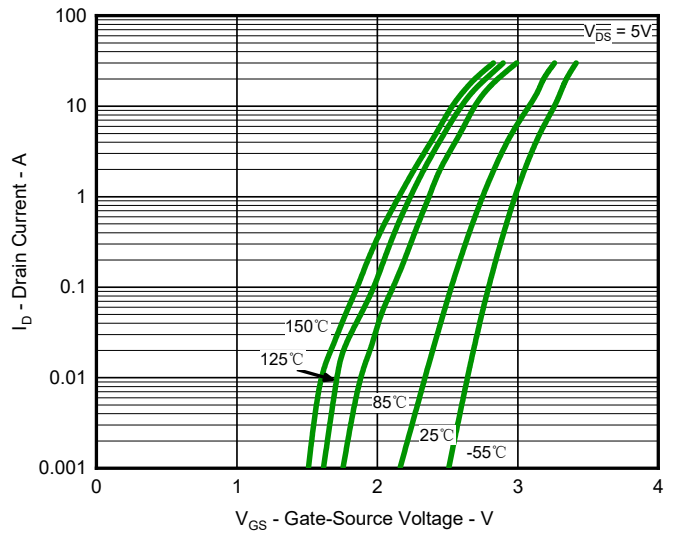

Fig.2 Typical Transfer Characteristic

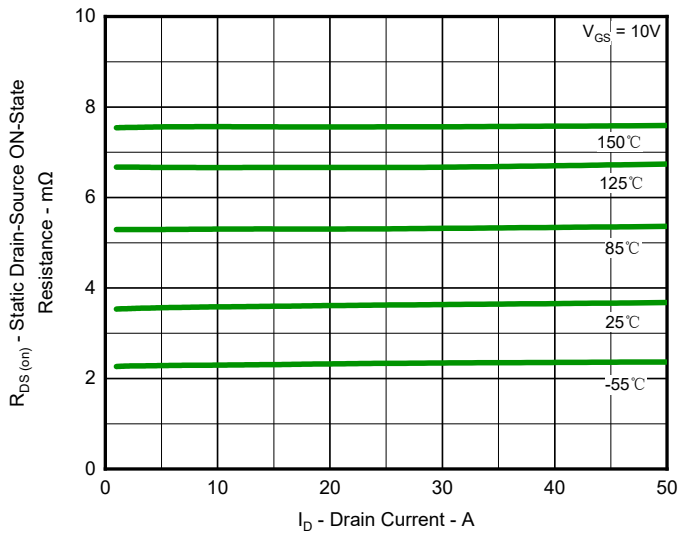

Fig.3 Typical On-Resistance vs Drain Current and Temperature

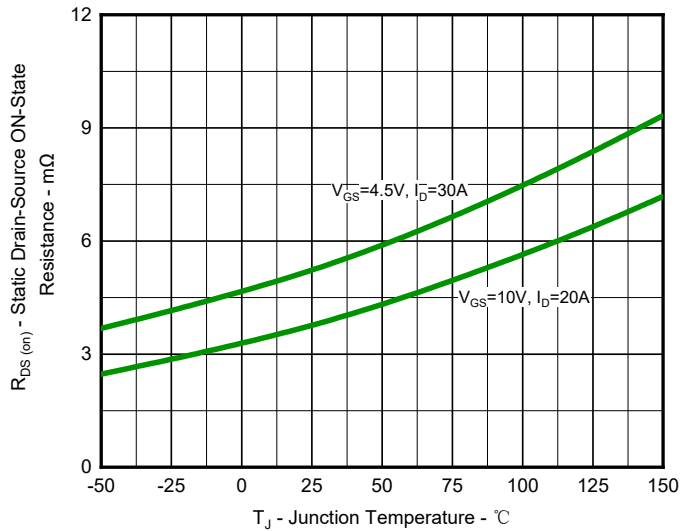

Fig.4 On-Resistance Variation with Temperature

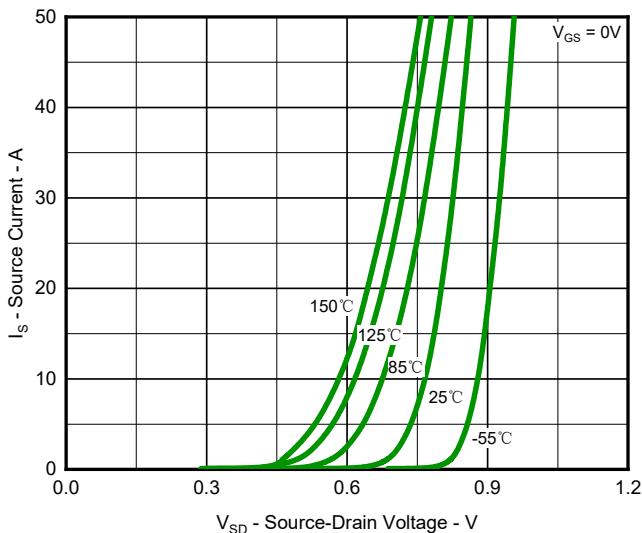

Fig.5 Diode Forward Voltage vs. Current

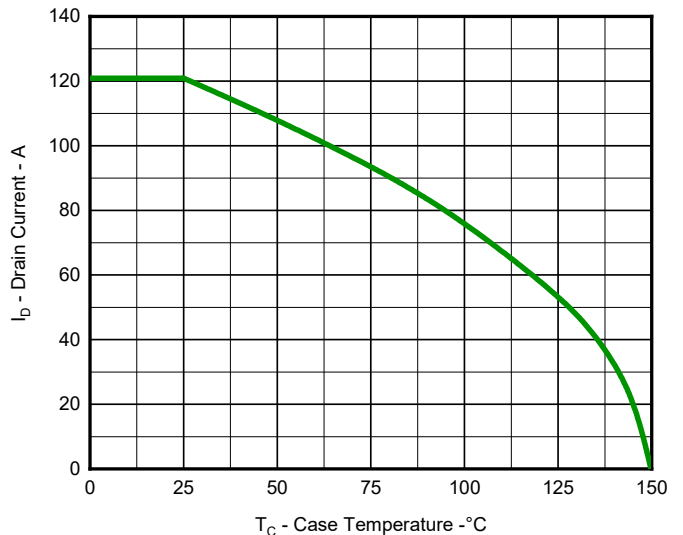

Fig.6 Maximum Drain Current vs. Case Temperature

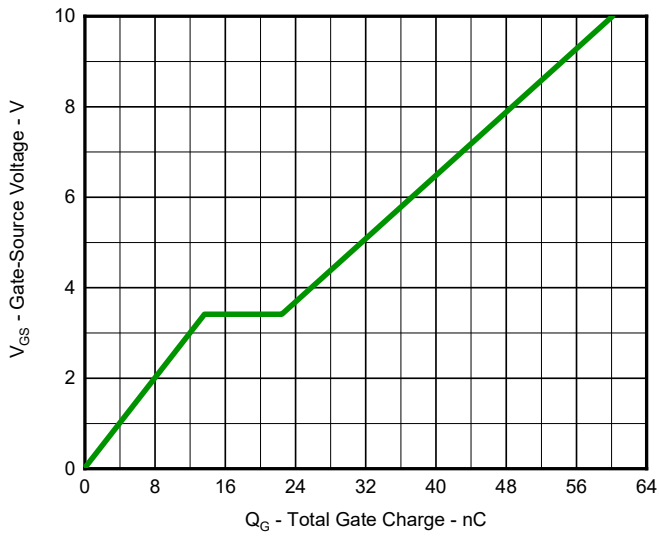

Fig.7 Gate Charge Characteristics

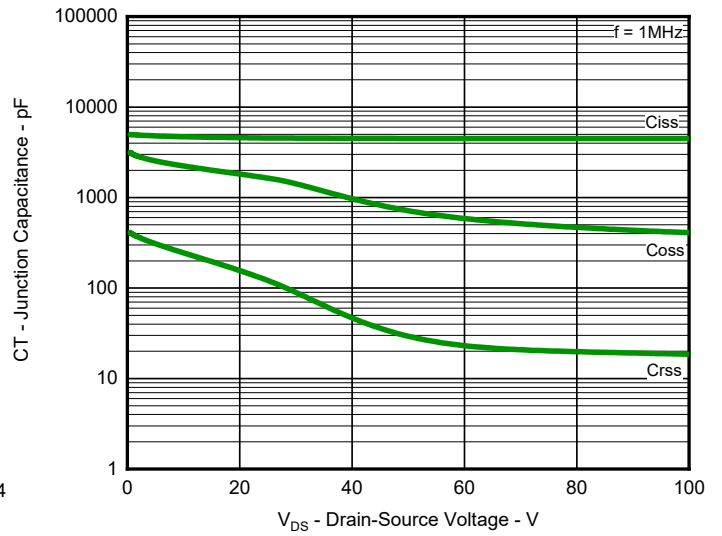

Fig.8 Typical Junction Capacitance

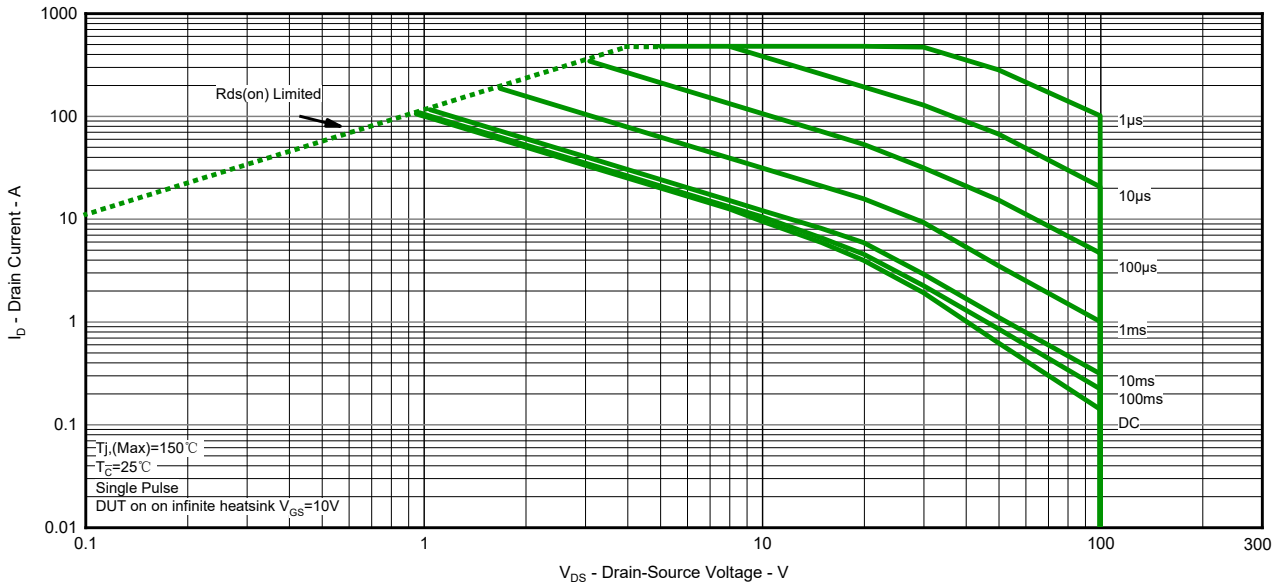

Fig.9 Safe Operation Area

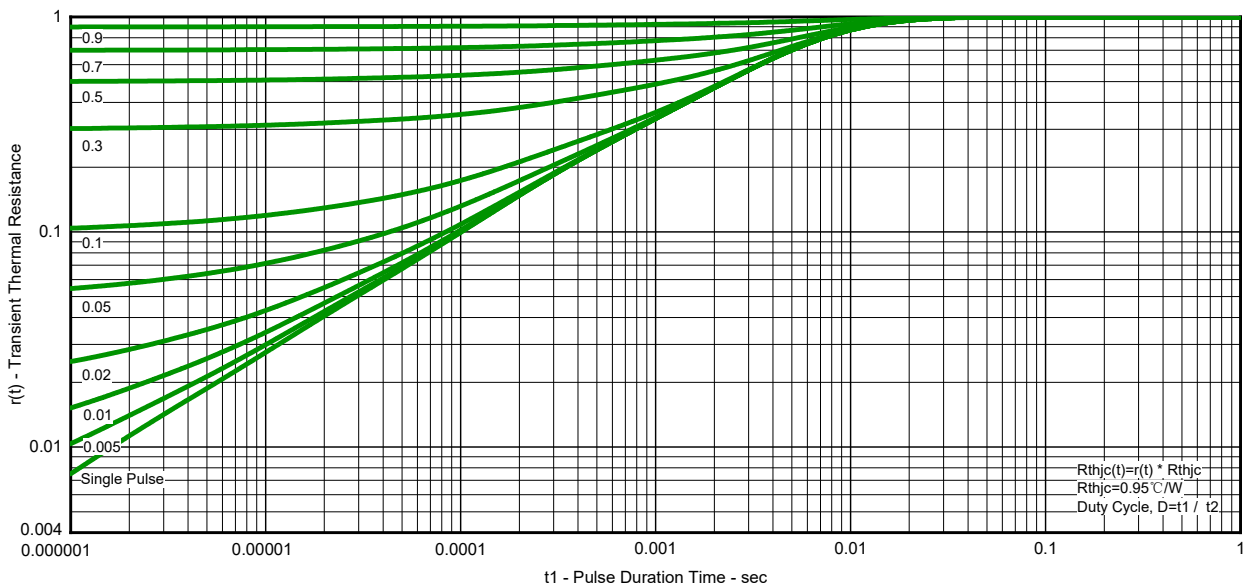
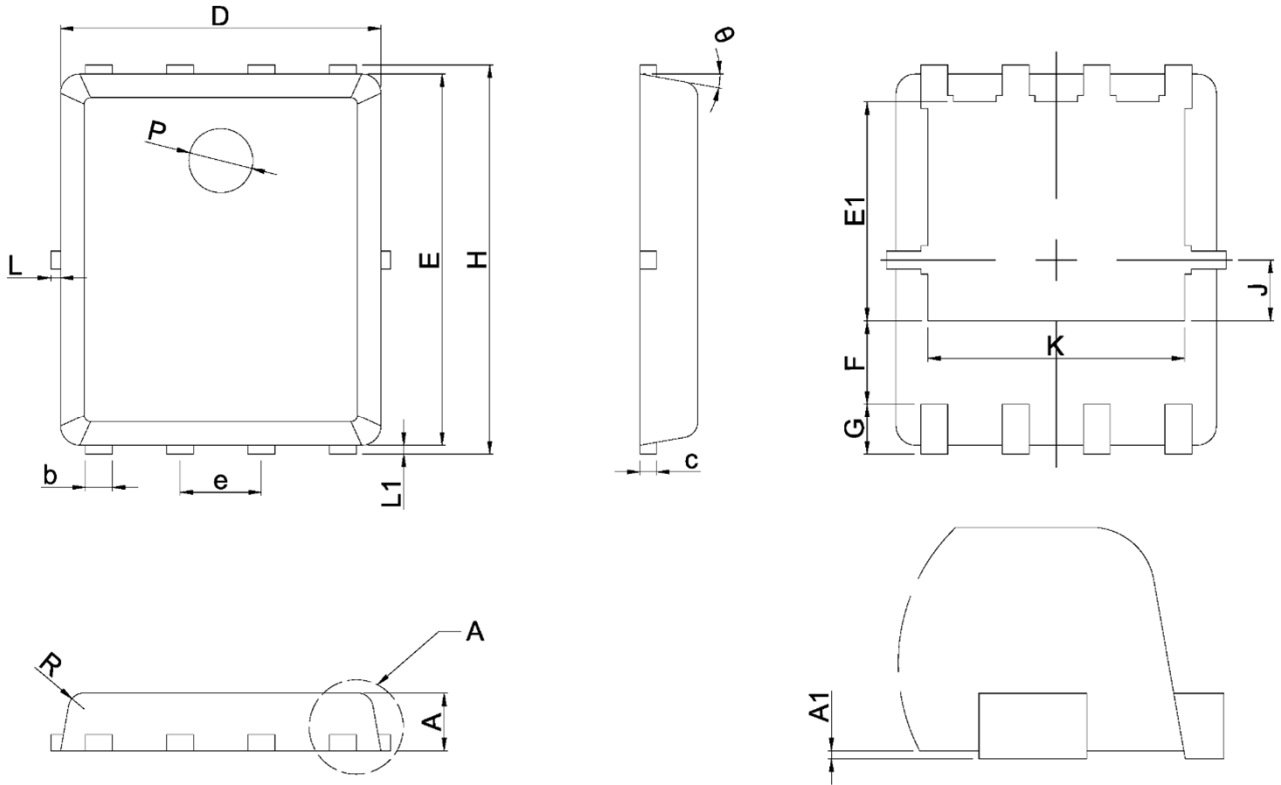

Fig.10 Transient Thermal Resistance

Product Dimension (PDFN5060-8L)



Dim	Millimeters		Inches	
	Min	Max	Min	Max
A	0.80	1.00	0.031	0.039
A1	0.00	0.05	0.000	0.002
b	0.35	0.49	0.014	0.019
c	0.254 Ref.		0.010 Ref.	
D	4.90	5.10	0.193	0.201
E	5.70	5.90	0.224	0.232
E1	3.35	3.65	0.132	0.144
e	1.27 BSC.		0.050 BSC.	
F	1.40 Ref.		0.055 Ref.	
G	0.60 Ref.		0.024 Ref.	
H	5.95	6.20	0.234	0.244
J	0.95 BSC.		0.037 BSC.	
K	4.00 Ref.		0.157 Ref.	
L	-	0.15	-	0.006
L1	0.10	0.18	0.004	0.007
P	1.00 Ref.		0.039 Ref.	
R	0.25 Ref.		0.010 Ref.	
theta	6°	14°	6°	14°

DETAIL "A"

N-Channel MOSFET

PSM8N10R4L

Ordering Information

Device	Package	Reel	Shipping
PSM8N10R4L	PDFN5060-8L	13"	5000 / Tape & Reel

Load With Information

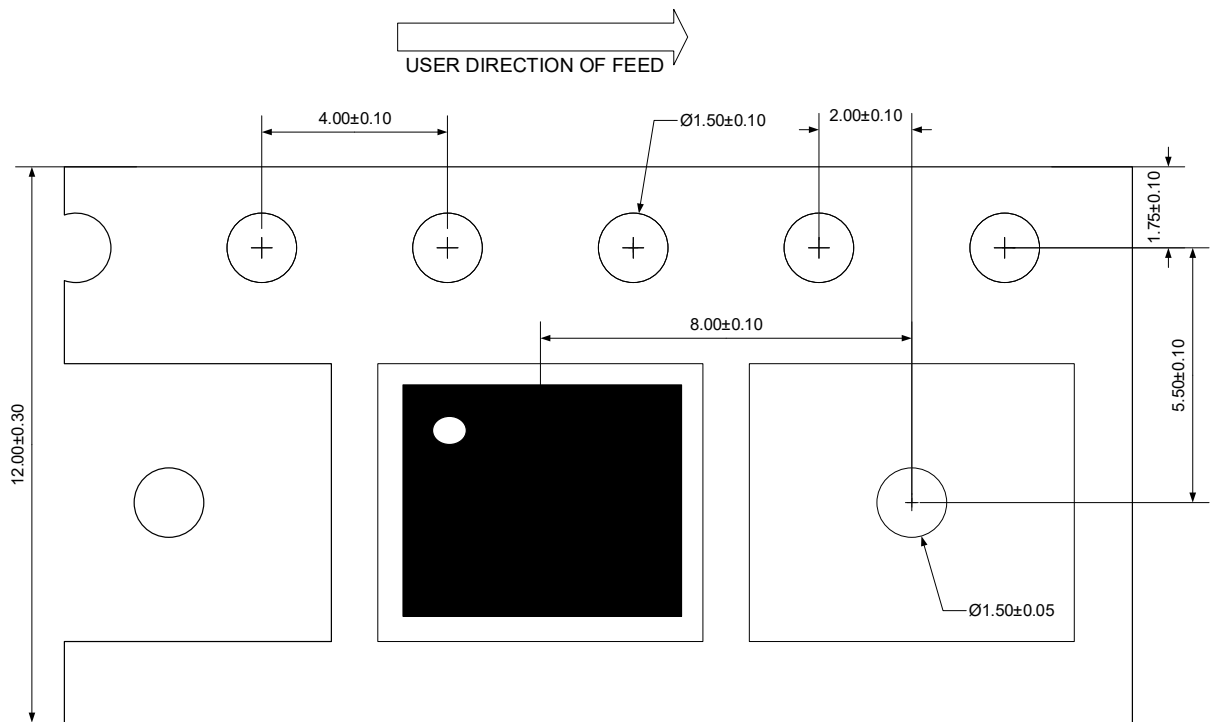

Unit:mm

IMPORTANT NOTICE

 and **Prisemi**[®] are registered trademarks of **Prisemi Electronics Co., Ltd** (Prisemi), Prisemi reserves the right to make changes without further notice to any products herein. Prisemi makes no warranty, representation or guarantee regarding the suitability of its products for any particular purpose, nor does Prisemi assume any liability arising out of the application or use of any product or circuit, and specifically disclaims any and all liability, including without limitation special, consequential or incidental damages. "Typical" parameters which may be provided in Prisemi data sheets and/or specifications can and do vary in different applications and actual performance may vary over time. All operating parameters, including "Typicals" must be validated for each customer application by customer's technical experts. Prisemi does not convey any license under its patent rights nor the rights of others. The products listed in this document are designed to be used with ordinary electronic equipment or devices, Should you intend to use these products with equipment or devices which require an extremely high level of reliability and the malfunction of which would directly endanger human life (such as medical instruments, aerospace machinery, nuclear-reactor controllers, fuel controllers and other safety devices), please be sure to consult with our sales representative in advance.

Website: <http://www.prisemi.com>

For additional information, please contact your local Sales Representative.

©Copyright 2009, Prisemi Electronics

 **Prisemi**[®] is a registered trademark of Prisemi Electronics.

All rights are reserved.