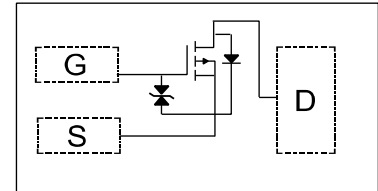

Description

The MOSFET provide the best combination of fast switching, low on-resistance and cost-effectiveness.

MOSFET Product Summary		
$V_{DS}(V)$	$R_{DS(on)}(\Omega)$	$I_D(mA)$
-20	0.45@ $V_{GS}=-4.5V$	-800
	0.62@ $V_{GS}=-2.5V$	
	0.86@ $V_{GS}=-1.8V$	

Top View
Absolute maximum rating@25°C

Parameter		Symbol	Value	Units
Drain-Source Voltage		V_{DS}	-20	V
Gate-Source Voltage		V_{GS}	± 10	V
Continuous Drain Current	Continuous	I_D	-800	mA
	Pulsed	I_{DP}	-1200	
Maximum Power Dissipation (Note 1)(Note 4)	$T_A=25^\circ C$	P_D	270	mW
	$T_A=70^\circ C$		170	
Maximum Power Dissipation (Note 2)(Note 4)	$T_A=25^\circ C$	P_D	240	mW
	$T_A=70^\circ C$		150	
Pulsed Drain Current(Note 3)		I_{DM}	-1.2	A
Operating Junction Temperature		T_J	150	$^\circ C$
Lead Temperature		T_L	260	$^\circ C$
Storage Temperature Range		T_{stg}	-55 to +150	$^\circ C$

Thermal resistance

Parameter		Symbol	Min.	Typ.	Max.	Units
Junction-to-Ambient Thermal Resistance (Note 1)	$t \leq 10$ s	$R_{\theta JA}$	-	350	400	$^\circ C/W$
	Steady State		-	395	460	$^\circ C/W$
Junction-to-Ambient Thermal Resistance (Note 2)	$t \leq 10$ s	$R_{\theta JA}$	-	390	445	$^\circ C/W$
	Steady State		-	450	515	$^\circ C/W$
Junction-to-Case Thermal Resistance		$R_{\theta JA}$	-	245	290	$^\circ C/W$

Electrical characteristics per line@25°C (unless otherwise specified)

Parameter	Symbol	Conditions	Min.	Typ.	Max.	Units
OFF CHARACTERISTICS						
Drain-to-Source Breakdown Voltage	BV_{DSS}	$I_D = -250\mu A, V_{GS} = 0V$	-20	-	-	V
Zero Gate Voltage Drain Current	I_{DSS}	$V_{DS} = -16V, V_{GS} = 0V$	-	-	-1	μA
Gate-to-source Leakage Current	I_{GSS}	$V_{DS} = 0V, V_{GS} = \pm 8V$	-	-	± 10	μA
ON CHARACTERISTICS						
Gate Threshold Voltage	$V_{GS(th)}$	$V_{GS} = V_{DS}, I_D = -250\mu A$	-0.45	-0.55	-0.95	V
Drain-to-source On-resistance (Note 5)	$R_{DS(on)}$	$V_{GS} = -4.5V, I_D = -700mA$	-	450	700	$m\Omega$
		$V_{GS} = -2.5V, I_D = -300mA$	-	620	850	$m\Omega$
		$V_{GS} = -1.8V, I_D = -100mA$	-	1000	1500	$m\Omega$
Forward Transconductance	g_{FS}	$V_{DS} = -5V, I_D = -450mA$	-	1.25	-	s
CHARGES, CAPACITANCES AND GATE RESISTANCE						
Input Capacitance	C_{ISS}	$V_{GS} = 0V, V_{DS} = -10V,$ $f = 1MHz$	-	72	-	μF
Output Capacitance	C_{OSS}		-	9.5	-	μF
Reverse Transfer Capacitance	C_{RSS}		-	9.8	-	μF
Total Gate Charge	$Q_{G(TOT)}$	$V_{GS} = -4.5V, V_{DS} = -10V,$ $I_D = -450mA$	-	0.9	-	nC
Threshold Gate Charge	$Q_{G(TH)}$		-	0.1	-	nC
Gate-to-Source Charge	Q_{GS}		-	0.15	-	nC
Gate-to-Drain Charge	Q_{GD}		-	0.3	-	nC
SWITCHING CHARACTERISTICS						
Turn-On Delay Time	$t_d(ON)$	$V_{GS} = -4.5V, V_{DS} = -10V,$ $I_D = -450mA$ $R_G = 6\Omega$	-	43	-	nS
Rise Time	t_r		-	137	-	nS
Turn-Off Delay Time	$t_d(OFF)$		-	1450	-	nS
Fall Time	t_f		-	2050	-	nS
BODY DIODE CHARACTERISTICS						
Forward Voltage	V_{SD}	$V_{GS} = 0V, I_S = -150mA$	-0.5	-0.65	-1.1	V

Note:

1. Surface mounted on FR4 Board using 1 square inch pad size, 1oz copper
2. Surface mounted on FR4 board using minimum pad size, 1oz copper
3. Pulse width < 380 μs , Single pulse
4. Maximum junction temperature $T_J = 150^\circ C$.
5. Pulse test: Pulse width < 380 us duty cycle < 2%.

Typical Characteristics

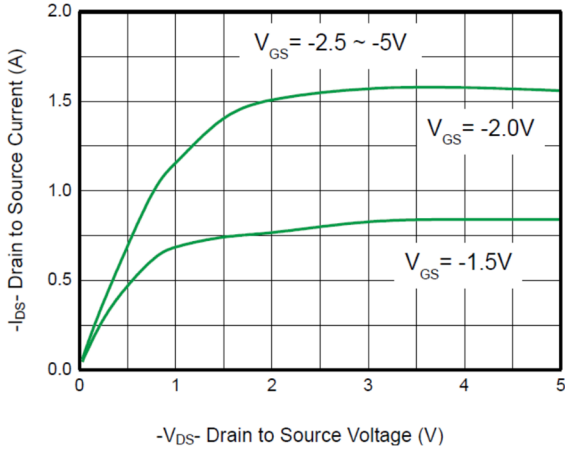

Fig 1. Output characteristics

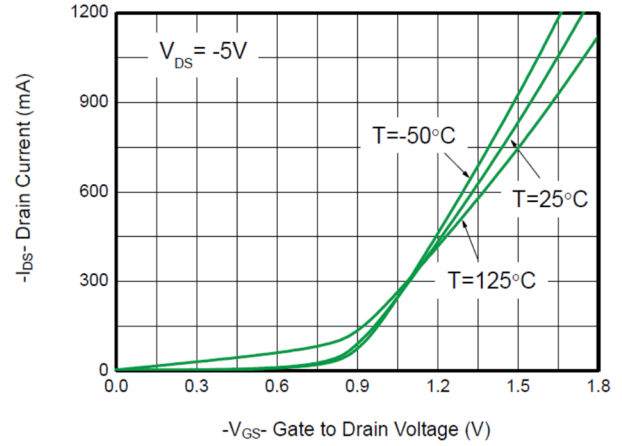

Fig 2. Transfer characteristics

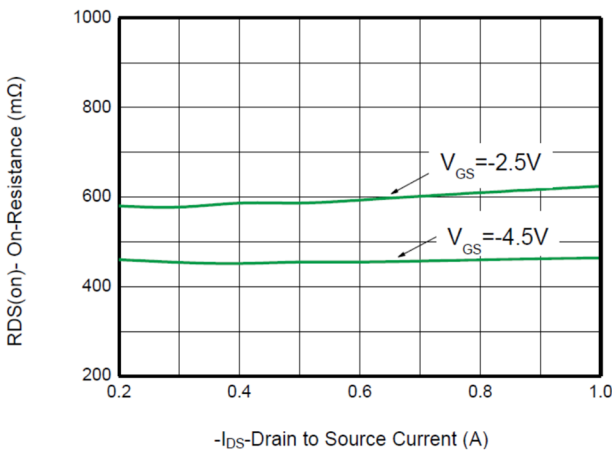

Fig 3. On-Resistance vs. Drain current

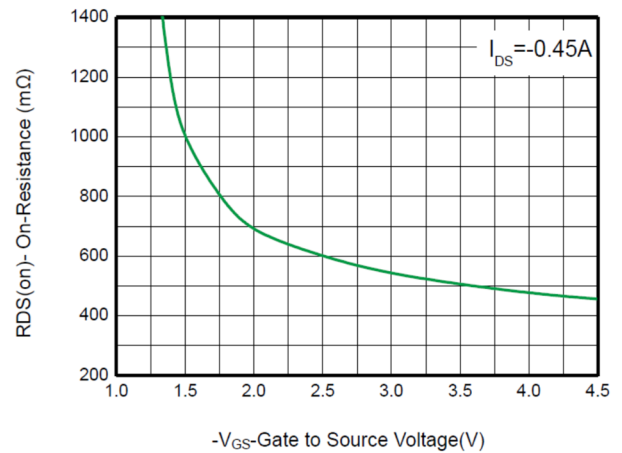

Fig 4. On-Resistance vs. Gate-to-Source voltage

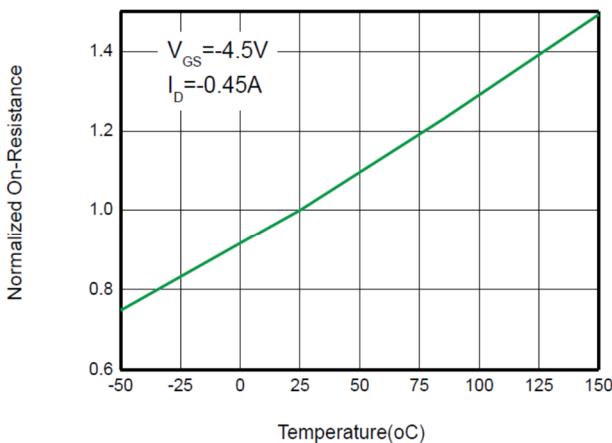

Fig 5. On-Resistance vs. Junction temperature

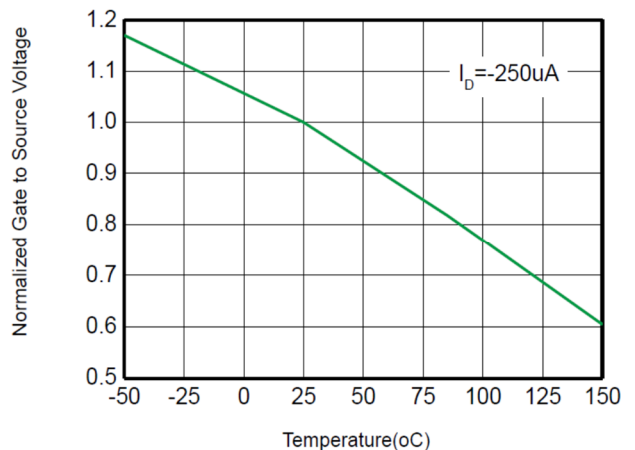

Fig 6. Threshold voltage vs. Temperature

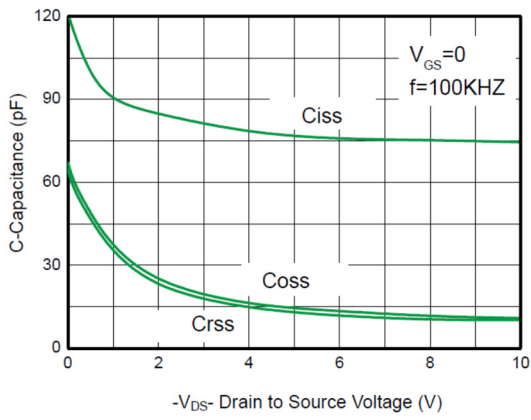

Fig 7. Capacitance.

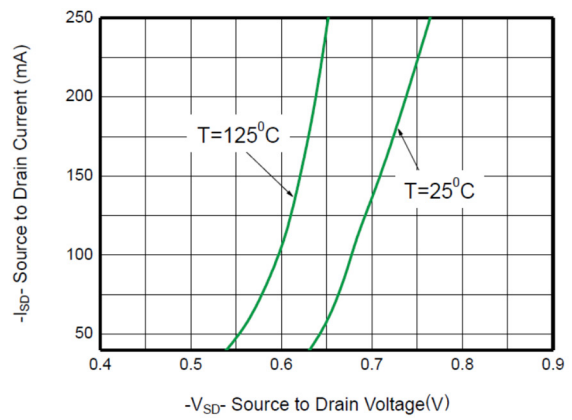
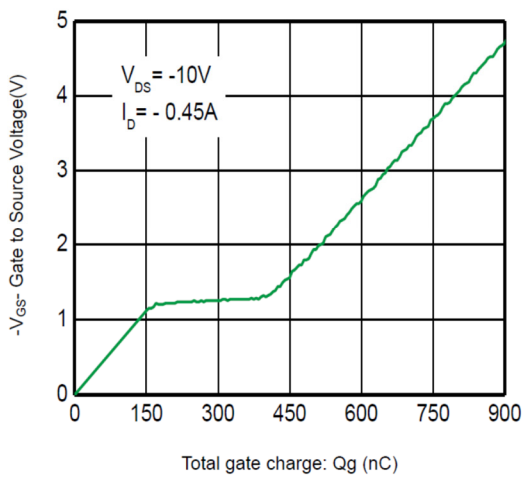
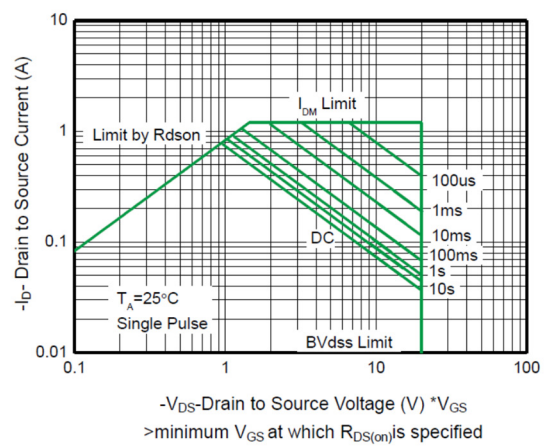
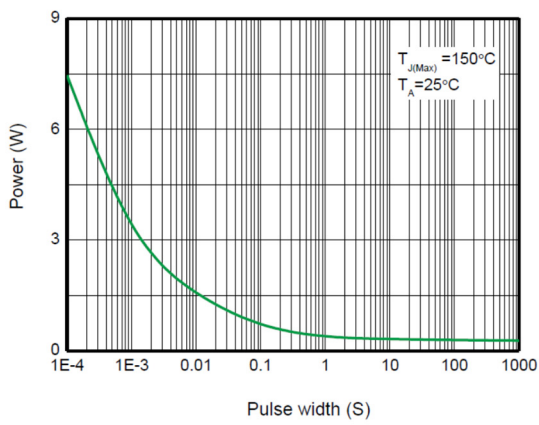
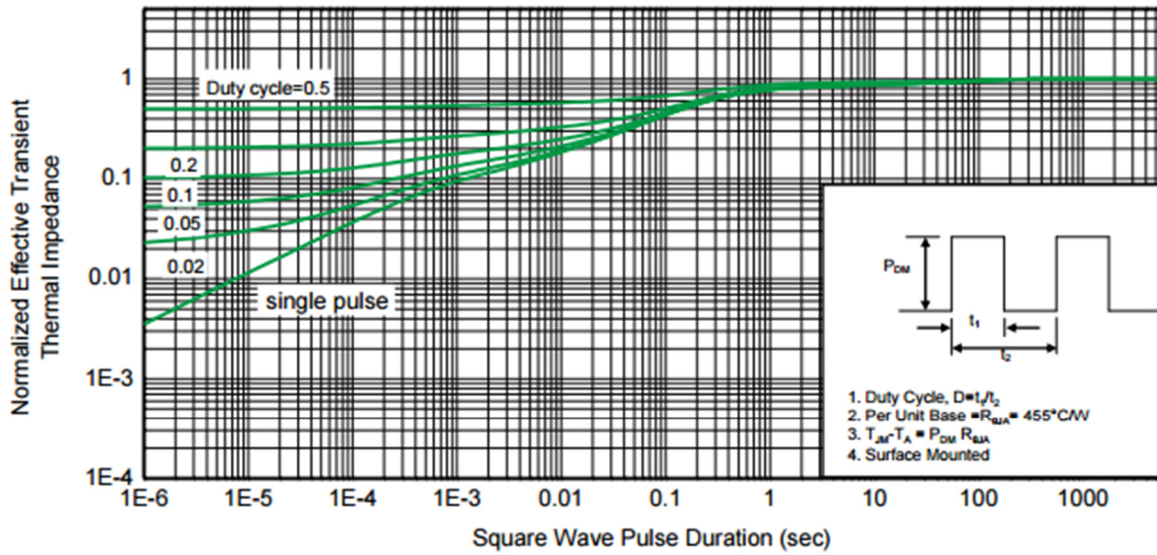

Fig 8. Body diode forward voltage





Transient thermal response (Junction-to-Ambient)

Product dimension (DFN1006-3L)

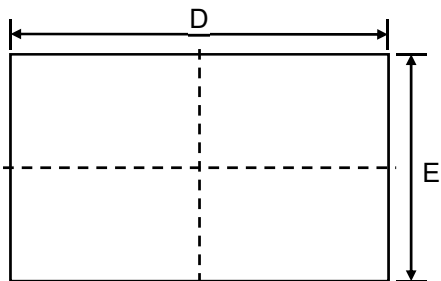

Top View

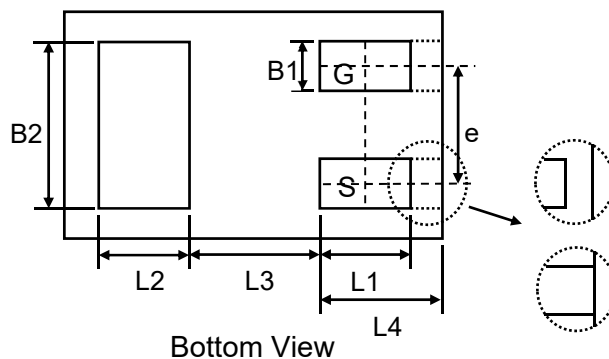

Bottom View

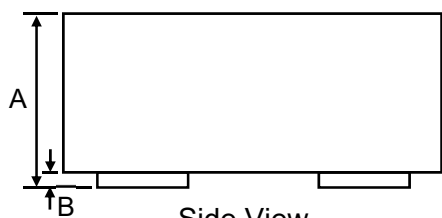

Side View

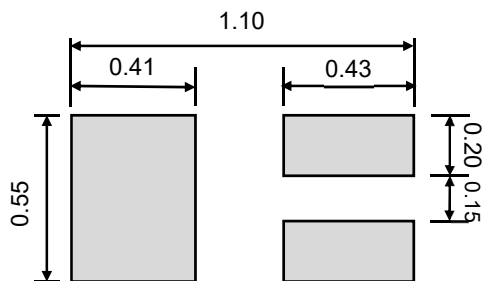

Suggested PCB Layout

Unit: mm

Dim	Millimeters		Inches	
	Min	Max	Min	Max
A	0.33	0.498	0.013	0.020
B	0.00	0.05	0.000	0.002
B1	0.10	0.20	0.004	0.008
B2	0.45	0.55	0.018	0.022
D	0.90	1.05	0.035	0.041
E	0.50	0.65	0.020	0.026
e	0.35		0.014	
L1	0.20	0.30	0.008	0.012
L2	0.20	0.30	0.008	0.012
L3	0.39		0.015	
L4	0.25	0.35	0.010	0.014

Marking information

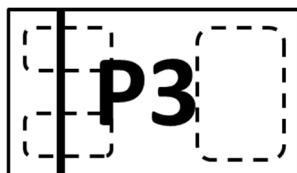

Ordering information

Device	Package	Reel	Shipping
PPM3FD20V1E	DFN1006-3L(Pb-Free)	7"	10000 / Tape & Reel

Load with information

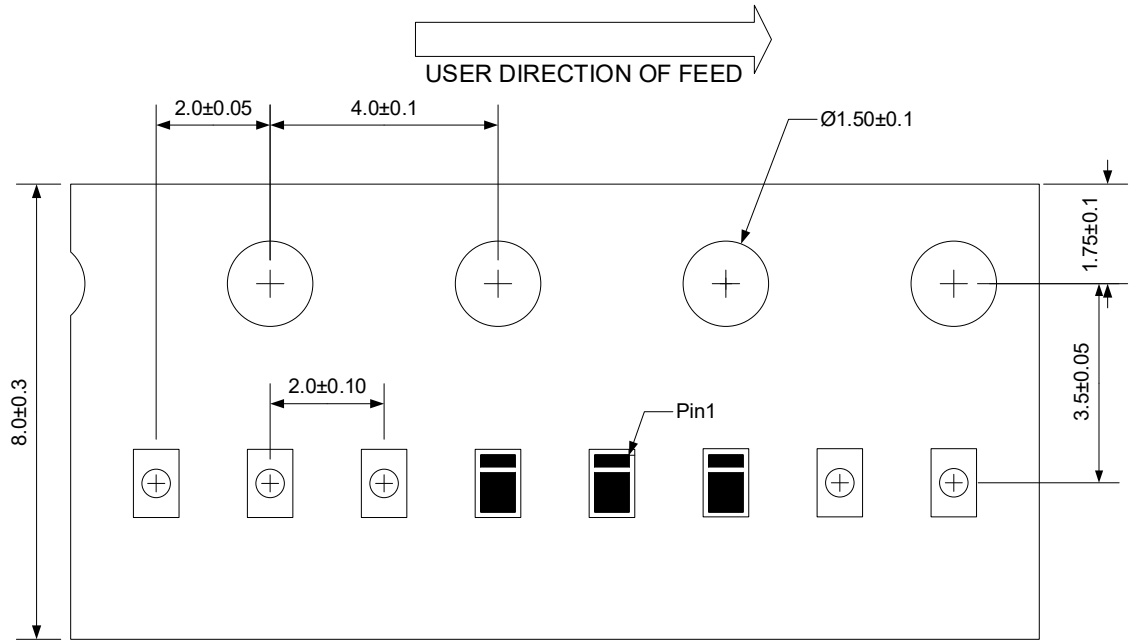

Unit:mm

IMPORTANT NOTICE

 and **Prisemi**[®] are registered trademarks of **Prisemi Electronics Co., Ltd (Prisemi)** ,Prisemi reserves the right to make changes without further notice to any products herein. Prisemi makes no warranty, representation or guarantee regarding the suitability of its products for any particular purpose, nor does Prisemi assume any liability arising out of the application or use of any product or circuit, and specifically disclaims any and all liability, including without limitation special, consequential or incidental damages. "Typical" parameters which may be provided in Prisemi data sheets and/or specifications can and do vary in different applications and actual performance may vary over time. All operating parameters, including "Typicals" must be validated for each customer application by customer's technical experts. Prisemi does not convey any license under its patent rights nor the rights of others. The products listed in this document are designed to be used with ordinary electronic equipment or devices, Should you intend to use these products with equipment or devices which require an extremely high level of reliability and the malfunction of with would directly endanger human life (such as medical instruments, aerospace machinery, nuclear-reactor controllers, fuel controllers and other safety devices), please be sure to consult with our sales representative in advance.

Website: <http://www.prisemi.com>

For additional information, please contact your local Sales Representative.

©Copyright 2009, Prisemi Electronics

 **Prisemi**[®] is a registered trademark of Prisemi Electronics.

All rights are reserved.