

## Description

The PSJMT065R170 is a high voltage MOSFET and is designed to have better characteristics, such as fast switching time, low gate charge, low on-state resistance and have a high rugged avalanche characteristics. This power MOSFET is usually used at high speed switching applications in power supplies, PWM motor controls, high efficient DC to DC converters and bridge circuits.

### MOSFET Product Summary

$V_{DS}(V)$	$R_{DS(on)}(m\Omega)$	$I_D(A)$
650	140@ $V_{GS} = 10V$	19

## Feature

- Fast Switching Capability
- Lead free product is acquired.
- Avalanche Energy Tested

## Applications

- PWM applications
- Load Switch
- Power Management
- DC-DC Converters

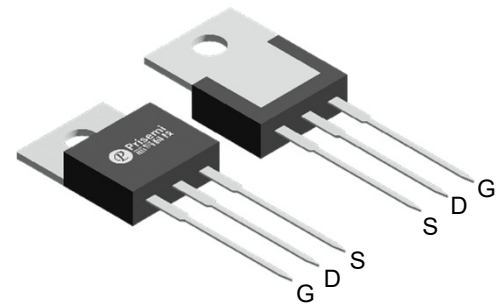

**TO-220  
Bottom View**

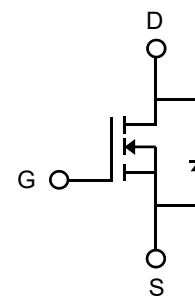

**Circuit Diagram**

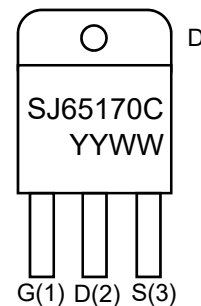

**Marking (Top View)**

## Absolute maximum rating@25°C

Rating	Symbol	Value	Units
Drain-Source Voltage	$V_{DS}$	650	V
Gate-Source Voltage	$V_{GS}$	$\pm 30$	V
Drain Current-Continuous <sup>1)</sup>	$I_D$	$T_C=25^\circ C$	19
		$T_C=100^\circ C$	12
Pulsed Drain Current <sup>2)</sup>	$I_{DM}$	55	A
Total Power Dissipation <sup>3)</sup>	$P_D$	171	W
Avalanche Current <sup>4)</sup>	$I_{AS}$	3.7	A
Avalanche Energy <sup>4)</sup>	$E_{AS}$	142	mJ
Thermal Resistance , Junction-to-Case <sup>6)</sup>	$R_{\theta JC}$	0.7	$^\circ C/W$
Thermal Resistance , Junction-to-Ambient <sup>5)</sup>	$R_{\theta JA}$	49.7	$^\circ C/W$
Junction and Storage Temperature Range	$T_J, T_{STG}$	-55~+150	$^\circ C$

## Electrical characteristics per line@25°C (unless otherwise specified)

Parameter	Symbol	Conditions	Min.	Typ.	Max.	Units
<b>Off Characteristics</b>						
Drain-Source Breakdown Voltage	$BV_{DSS}$	$V_{GS} = 0V, I_D = 250\mu A$	650	-	-	V
Zero Gate Voltage Drain Current	$I_{DSS}$	$V_{DS} = 600V, V_{GS} = 0V$	-	-	1.0	$\mu A$
Gate-Body Leakage Current	$I_{GSS}$	$V_{GS} = \pm 30V, V_{DS} = 0V$	-	-	$\pm 100$	nA
<b>On Characteristics</b>						
Gate Threshold Voltage	$V_{GS(th)}$	$V_{DS} = V_{GS}, I_D = 250\mu A$	2.5	2.8	3.5	V
Drain-Source On-State Resistance	$R_{DS(ON)}$	$V_{GS} = 10V, I_D = 1A$	-	140	170	m $\Omega$
<b>Dynamic Characteristics<sup>7)</sup></b>						
Input Capacitance	$C_{iss}$	$V_{DS} = 100V, V_{GS} = 0V,$ $f = 1.0MHz$	-	1508	-	pF
Output Capacitance	$C_{oss}$		-	56	-	
Reverse Transfer Capacitance	$C_{rss}$		-	1.2	-	
<b>Switching Characteristics<sup>7)</sup></b>						
Turn-on Delay Time	$t_{d(on)}$	$V_{DS} = 400V, V_{GS} = 10V,$ $I_D = 1A, R_G = 10\Omega$	-	16	-	ns
Turn-on Rise Time	$t_r$		-	10	-	
Turn-Off Delay Time	$t_{d(off)}$		-	149	-	
Turn-Off Fall Time	$t_f$		-	58	-	
Total Gate Charge	$Q_g$	$V_{DS} = 480V, V_{GS} = 10V,$ $I_D = 1A$	-	32.7	-	nC
Gate-Source Charge	$Q_{gs}$		-	4.2	-	
Gate-Drain Charge	$Q_{gd}$		-	5.1	-	
Gate Resistance	$R_g$	$f=1MHz$ , Open Drain	-	2.7	-	$\Omega$
<b>Drain-Source Diode Characteristics</b>						
Diode Forward Voltage	$V_{SD}$	$V_{GS} = 0V, I_S = 1A$	-	0.7	1.2	V
Body Diode Reverse Recovery Time	$t_{rr}$	$I_F = 1A, V_R = 200V,$ $dI_F/dt = 100A/\mu s$	-	115	-	ns
Body Diode Reverse Recovery Charge	$Q_{rr}$		-	0.6	-	$\mu C$
Peak Reverse Recovery Current	$I_{rrm}$		-	10.7	-	A

## Notes:

1. Computed continuous current assumes the condition of  $T_{J\_Max}$  while the actual continuous current depends on the thermal & electro-mechanical application board design.
2. Repetitive Rating: Pulse width limited by maximum junction temperature( $T_{J\_Max}=150^\circ C$ ).
3. Pulse Test: Pulse Width  $\leq 300\mu s$ , Duty Cycle  $\leq 2\%$ .
4. This single-pulse measurement was taken under the following condition [ $L=20mH, V_{GS}=10V, V_{DS}=150V$ ]while it's value is limited by  $T_{J\_Max}=150^\circ C$ .
5. Device mounted on FR-4 substrate PC board, 2oz copper, with minimum recommended pad layout.
6. Device mounted on infinite heatsink.
7. Guaranteed by design, not subject to production.

Typical Characteristics

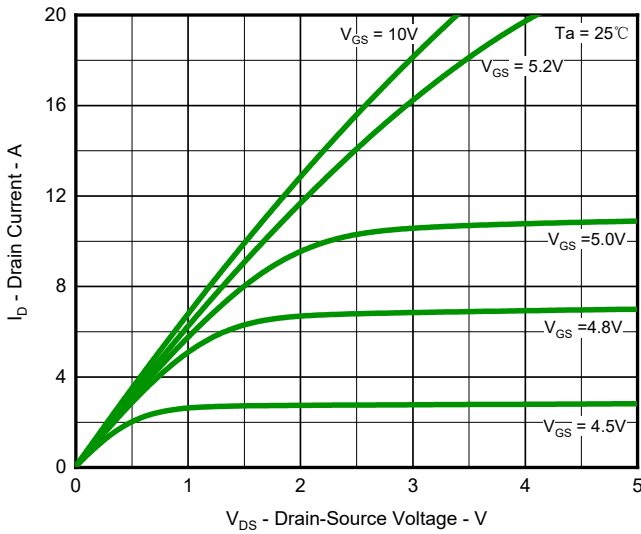

Fig.1 Output Characteristics

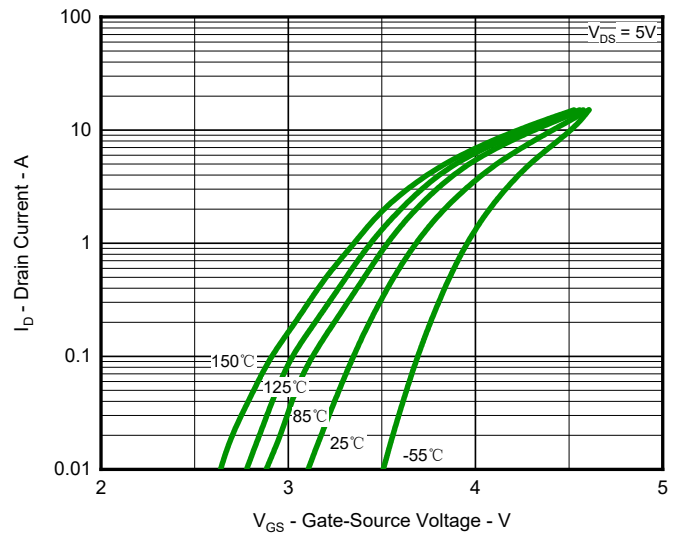

Fig.2 Typical Transfer Characteristic

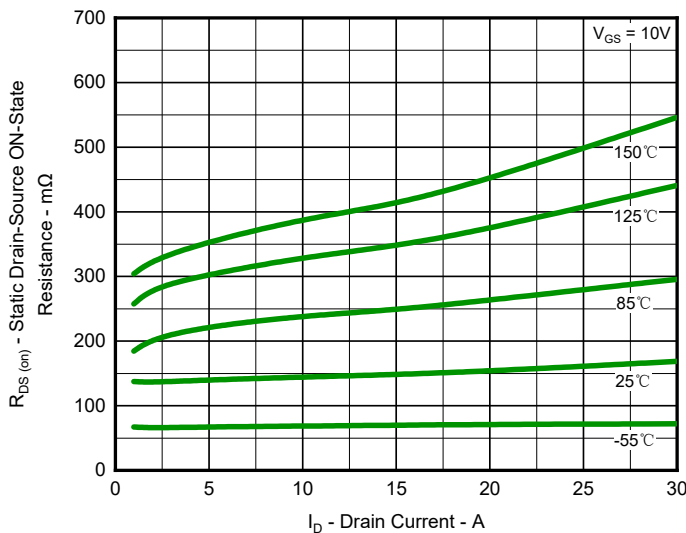

Fig.3 Typical On-Resistance vs Drain Current and Temperature

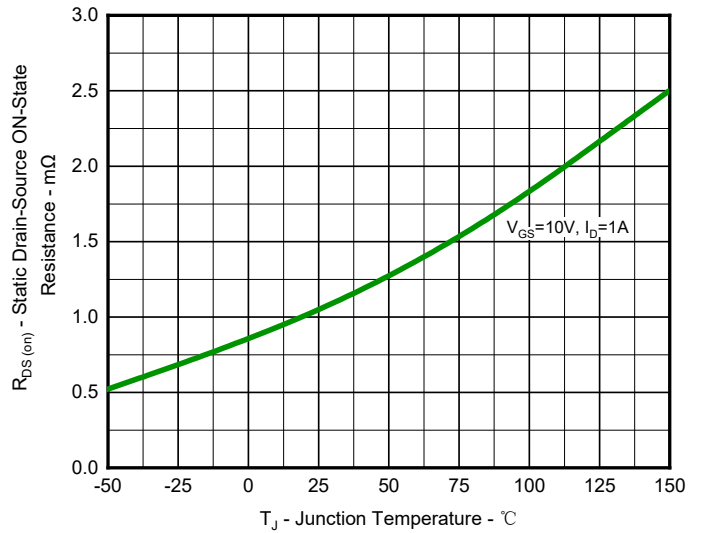

Fig.4 On-Resistance Variation with Temperature

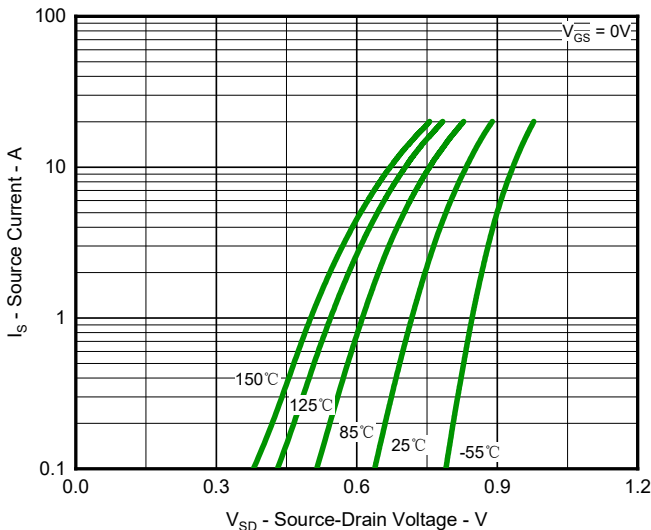

Fig.5 Diode Forward Voltage vs. Current

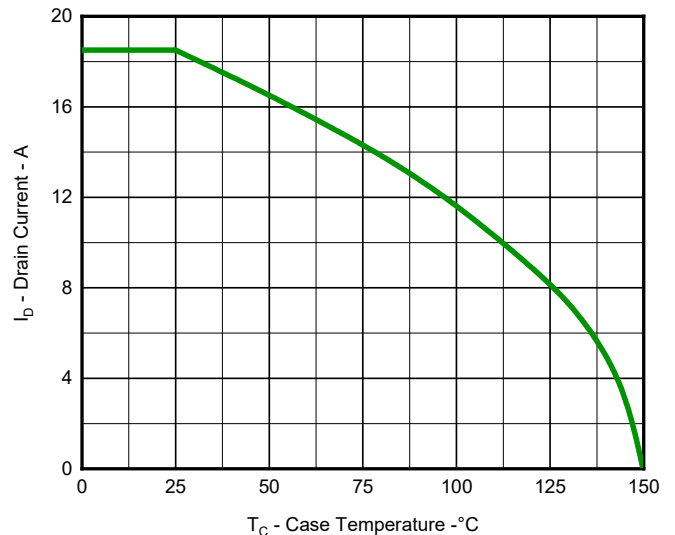

Fig.6 Maximum Drain Current vs. Case Temperature

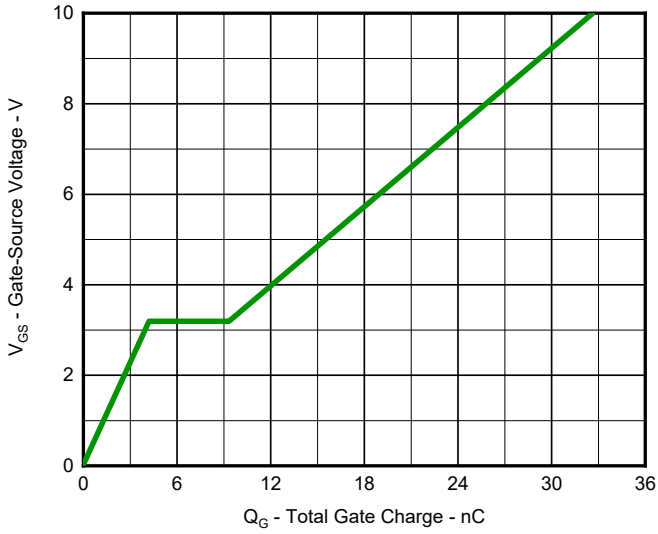

Fig.7 Gate Charge Characteristics

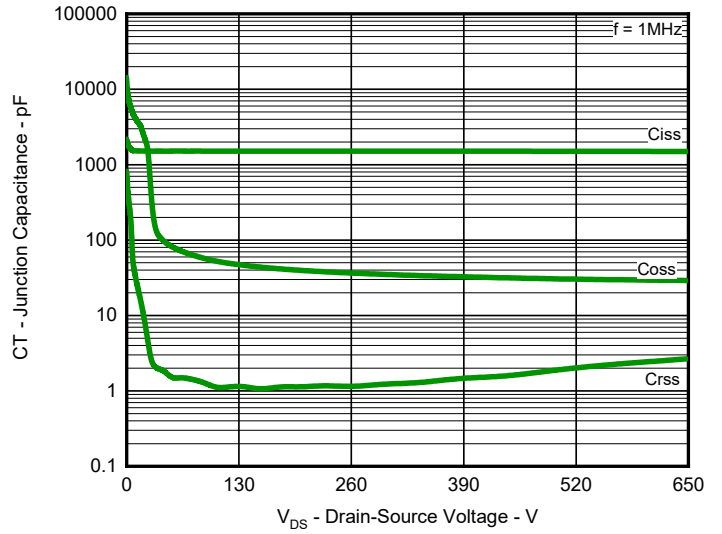

Fig.8 Typical Junction Capacitance

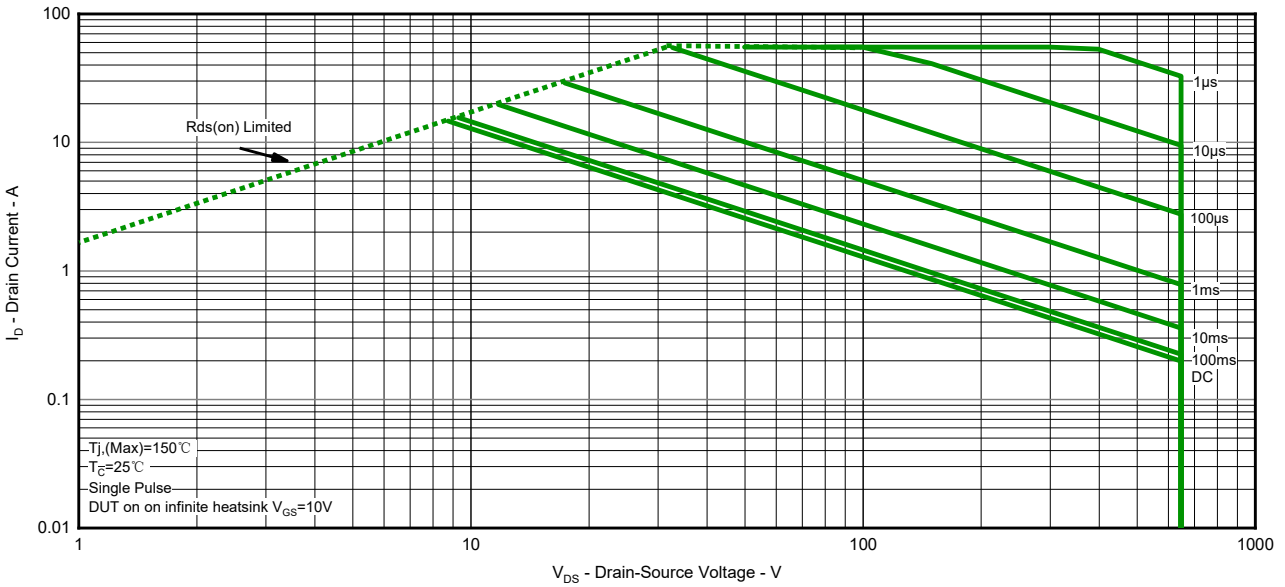

Fig.9 Safe Operation Area

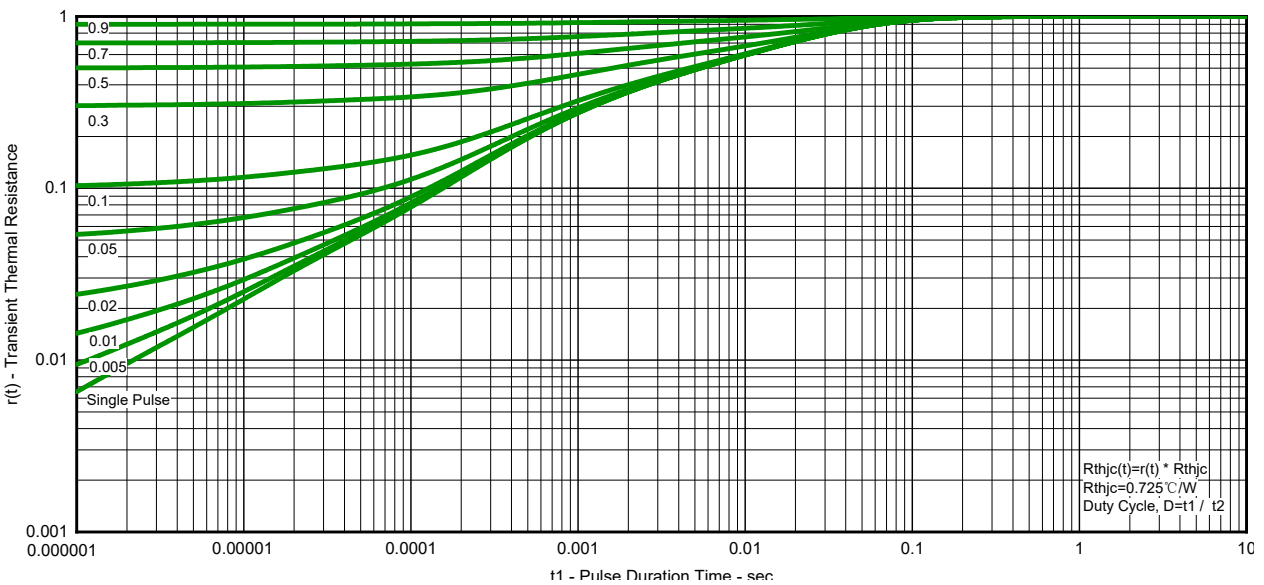
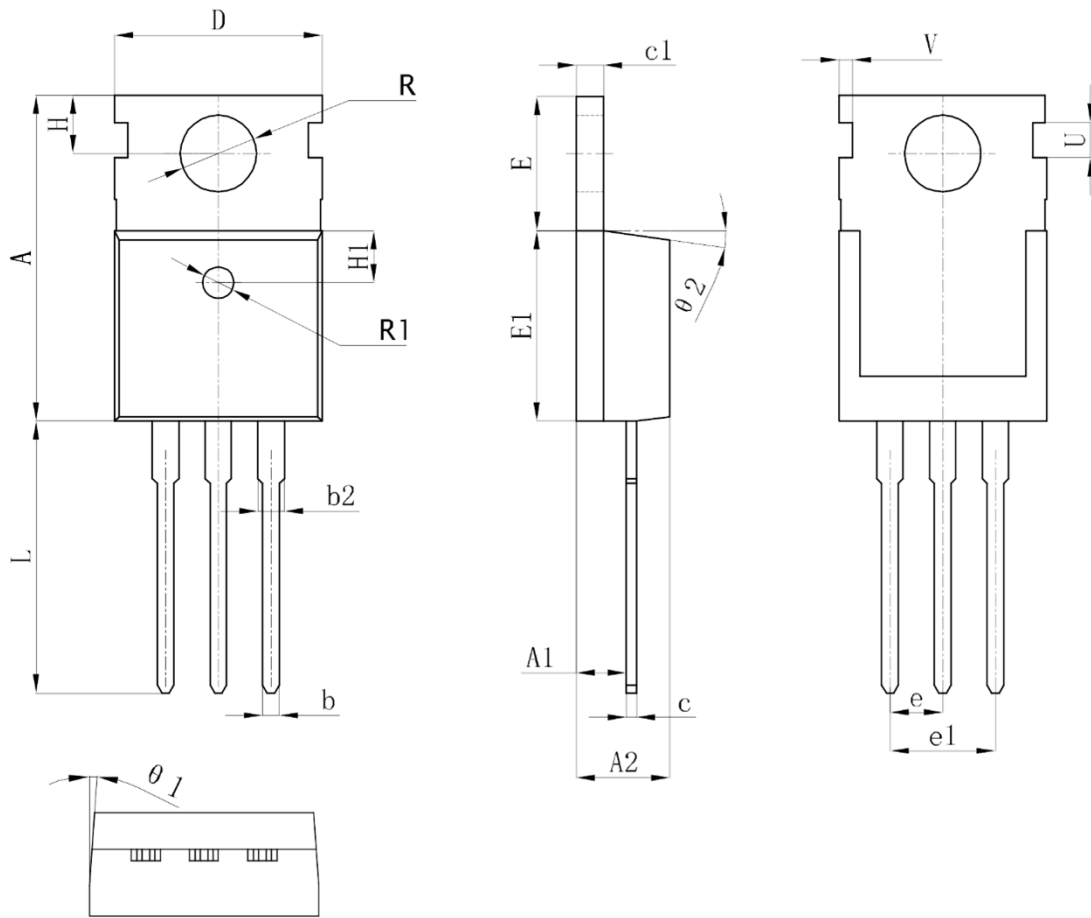



Fig.10 Transient Thermal Resistance

Product dimension (TO-220)



Dim	Millimeters		Inches		Dim	Millimeters		Inches	
	Min	Max	Min	Max		Min	Max	Min	Max
A	15.40	15.80	0.606	0.622	e1	4.84	5.32	0.191	0.209
A1	2.35	2.50	0.093	0.098	H	2.73	2.87	0.107	0.113
A2	4.40	4.70	0.173	0.185	H1	2.40	2.60	0.094	0.102
b	0.70	0.90	0.028	0.035	L	13.02	13.72	0.513	0.540
b2	1.18	1.44	0.046	0.057	R	3.50	3.63	0.138	0.143
c	0.48	0.56	0.019	0.022	R1	1.40	1.60	0.055	0.063
c1	1.29	1.32	0.051	0.052	U	1.65	1.85	0.065	0.073
D	9.80	10.20	0.386	0.402	V	0.58	0.78	0.023	0.031
E	6.40	6.60	0.252	0.260	$\theta_1$	2°	3°	2°	3°
E1	9.00	9.20	0.354	0.362	$\theta_2$	6.5°	7.5°	6.5°	7.5°
e	2.42	2.66	0.095	0.105					

**IMPORTANT NOTICE**

 and **Prisemi**<sup>®</sup> are registered trademarks of **Prisemi Electronics Co., Ltd** (Prisemi), Prisemi reserves the right to make changes without further notice to any products herein. Prisemi makes no warranty, representation or guarantee regarding the suitability of its products for any particular purpose, nor does Prisemi assume any liability arising out of the application or use of any product or circuit, and specifically disclaims any and all liability, including without limitation special, consequential or incidental damages. "Typical" parameters which may be provided in Prisemi data sheets and/or specifications can and do vary in different applications and actual performance may vary over time. All operating parameters, including "Typicals" must be validated for each customer application by customer's technical experts. Prisemi does not convey any license under its patent rights nor the rights of others. The products listed in this document are designed to be used with ordinary electronic equipment or devices, Should you intend to use these products with equipment or devices which require an extremely high level of reliability and the malfunction of which would directly endanger human life (such as medical instruments, aerospace machinery, nuclear-reactor controllers, fuel controllers and other safety devices), please be sure to consult with our sales representative in advance.

Website: <http://www.prisemi.com>

For additional information, please contact your local Sales Representative.

©Copyright 2009, Prisemi Electronics

 **Prisemi**<sup>®</sup> is a registered trademark of Prisemi Electronics.

All rights are reserved.